



GRUPPOFOX

IL GIORNO DI FOX



GRUPPO **FOX**

IL GIORNO DI FOX

Il linguaggio formale della **Collezione Il Giorno Di Fox** si presenta attraverso uno spirito prettamente contemporaneo e razionale, dal sapore moderno.

Un'eleganza accennata e mai leziosa esalta lo stile easy-chic che diviene tratto distintivo.

Il Giorno di Fox prende vita nel centro di ricerca e design del **Gruppo Fox**, grazie a un team altamente qualificato e sensibile alle esigenze delle dinamiche domestiche e collettive, da declinare attraverso un gusto in evoluzione continua, eppure sempre rassicurante e fortemente identitario del marchio Fox.

La collezione viene presentata in architetture razionali e sofisticate, a tratti pindariche affinché l'esperienza di comfort sia veicolata attraverso un viaggio emozionale che coinvolge tutti i sensi.

Legni pregiati, marmi, morbidi drappaggi e pareti materiche accolgono i prodotti che prendono vita insieme ad elementi di design che impreziosiscono la scena in veste di accessori esclusivi.

Pellami di qualità, tessuti morbidi e dalle textures ricercate conferiscono personalità uniche e nuove ed il concetto del tailor made si racconta attraverso la sua preziosa maestosità.

La ricca disponibilità di elementi standard semplifica il concetto di componibilità in modo tale da poter rispondere alle più svariate esigenze di progettazione.

Questa selezione accurata apre il dialogo ad un gusto nuovo, la visione progettuale del brand coincide facilmente con quella dell'utente Fox, ed il viaggio ha inizio...





FOX BY DAY

The formal language of the Fox by Day Collection presents itself through a purely contemporary and rational spirit, with a modern flavour.

A hinted and never affected elegance enhances the easy-chic style which becomes a distinctive feature.

Fox by Day comes to life in the research and design center of Gruppo Fox, thanks to a highly qualified team sensitive to the needs of domestic and collective dynamics, to be expressed through a continuously evolving taste, yet always reassuring and strongly identifying the Fox brand.

The collection is presented in rational and sophisticated architectures, sometimes pindaric, so that the experience of comfort is conveyed through an emotional journey that involves all the senses.

Precious woods, marbles, soft drapes and material walls welcome the products that come to life together with design elements that embellish the scene as exclusive accessories.

Quality leathers, soft fabrics and refined textures give unique and new personalities and the concept of tailor made is told through its precious majesty.

The rich availability of standard elements simplifies the concept of modularity in such a way as to be able to respond to the most varied design needs.

This careful selection opens the dialogue to a new taste, the brand's design vision easily coincides with that of the Fox customer, and the journey begins...

SHOWROOM

SHOWROOM



Inauguriamo il nostro showroom, luogo dinamico, uno spazio che racconta di noi. Fortemente convinti che i valori tramandati nel tempo costituiscano le basi più solide su cui costruire il nostro futuro, prendiamo atto di quanto anche sia sempre più necessario comunicare un *know how* improntato su qualità e prodotto ma anche sull'identità di chi lo crea.

E' proprio in questo spazio, che si sviluppa attraverso architetture rigorose e morbidi dettagli, che il cliente Gruppo Fox deve poter trovare un contesto stimolante, conoscere nuove essenze e filati, scoprire pellami e lavorazioni, senza tralasciare le importanti relazioni che si consolidano durante le visite.

La nostra area industriale diviene cornice per questo viaggio, che fa vivere la calda sensazione di un ambiente domestico e si declina attraverso pezzi vintage e giochi di luce volti ad esaltare i materiali selezionati, parquet e resine per i pavimenti, pareti materiche e cristalli in sospensione, i nostri prodotti e quindi vostri fedeli compagni di vita domestica, firmati **Gruppo Fox**.

We inaugurate our showroom, a dynamic place, a space that tells about us. Strongly convinced that the values handed down over time constitute the most solid foundations on which to build our future, we take note of how much more necessary it is to communicate a know-how based on quality and product but also on the identity of those who create it.

It is precisely in this space, which develops through rigorous architectures and soft details, that the Gruppo Fox customer must be able to find a stimulating context, get to know new essences and yarns, discover leathers and processes, without neglecting the important relationships that are consolidated during the visits.

Our industrial area becomes the setting for this journey, which brings to life the warm feeling of a domestic environment and is declined through vintage pieces and plays of light aimed at enhancing the selected materials, parquet and resin for the floors, material walls and suspended crystals, our products and therefore your faithful companions in domestic life, signed by Gruppo Fox.



DIVANI E POLTRONE
SOFAS AND ARMCHAIRS



Duepuntozero pag. 14



Grecale pag. 44



Amalfi pag. 200



Albert pag. 210



Link pag. 54



Levante pag. 68



Alpha pag. 222



Infinity Soft pag. 230



Levante Air pag. 76



Boss pag. 84



Metropolitan pag. 234



Asso pag. 242



Now Soft pag. 104



Slaid pag. 126



Arrigo pag. 244



Simon pag. 248



Hugo pag. 136



Gran Milano pag. 148



Brad pag. 258



Hector pag. 172



Alexis pag. 184

POLTRONCINE
SMALL ARMCHAIRS



Artemide pag. 264



Daphne pag. 266



Charlotte pag. 290



Parigi pag. 292



Diana pag. 268



Mirto pag. 270



Fanny pag. 294



Lapalla pag. 296



Partenope pag. 272



Tecla pag. 274



Linda pag. 300



Margot pag. 304



Athena pag. 276



Hydra pag. 278



Milady pag. 306



Susanna pag. 308



Kea pag. 280



Olympia pag. 282



Pouff pag. 310



Albertina pag. 286



Arrighina pag. 288

SCHEDE TECNICHE
TECHNICAL SHEETS

pag. 312

DIVANI E POLTRONE

SOFAS AND ARMCHAIRS



Duepuntozero

Gruppo Fox Design































Grecale

Gruppo Fox Design











Link

Gruppo Fox Design















Levante

Gruppo Fox Design









Levante Air

Gruppo Fox Design









Boss

Gruppo Fox Design





















Now Soft

Gruppo Fox Design























Slaid

Gruppo Fox Design







Il silenzioso meccanismo presente nelle sedute permette a queste ultime un'escursione di 40 cm, facendo leva semplicemente con il proprio peso corporeo.

- Con la seduta avanzata troviamo una soluzione relax, profonda e accogliente.
- Con la seduta rientrata, invece, si crea una soluzione di conversazione o lettura

The silent mechanism present in the seats allows the latter to extract up to 40 cm, simply leveraging with one's own body weight.

- *With the advanced seat we find a relaxing, deep and welcoming solution.*
- *With the seat retracted, however, a conversation or reading solution is created.*







Hugo
Gruppo Fox Design













Gran Milano

Gruppo Fox Design

























Nell'immagine si evidenzia il bracciolo standard del modello Gran Milano, altezza contenuta e forma compatta.

The image shows the standard armrest of the Gran Milano model, low height and compact shape.



Nell'immagine si evidenzia il bracciolo "B", con altezza pari a quella della struttura posteriore, la cui inclinazione interna dona slancio ulteriore al mood del divano.

The image shows the armrest "B", with a height equal to that of the rear structure, whose internal inclination gives further impetus to the mood of the sofa.



Hector

Gruppo Fox Design









Il silenzioso meccanismo dello schienale utilizzato per "Hector" crea due pratiche situazioni:

- Nella prima troviamo una soluzione relax con seduta profonda e accogliente.
- Nella seconda invece, lo schienale in avanti crea una situazione di conversazione o di lettura.



The silent mechanism of the back used for "Hector" creates two practical situations:

- The first is a relaxing solution with a deep and welcoming seat.*
- The second features a more upright back, creating a conversation or reading setting.*





Alexis

Gruppo Fox Design











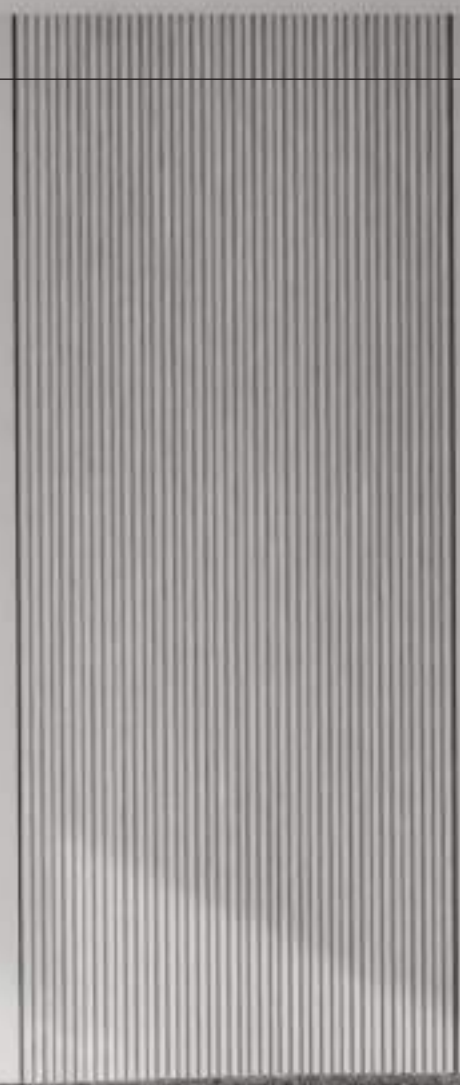





Amalfi

Gruppo Fox Design











Albert

Gruppo Fox Design



BERT

PERICOLO
DEL PAVIMENTO
PERICOLO











Alpha

Gruppo Fox Design









Infinity Soft

Gruppo Fox Design





Metropolitan

Gruppo Fox Design









ASSO

Gruppo Fox Design



Arrigo

Gruppo Fox Design



Finitura con bordo a "cordoncino" in contrasto (optional)
Finish with "creasing" edge in contrast (optional)



Simon

Gruppo Fox Design











Brad

Gruppo Fox Design





POLTRONCINE

SMALL ARMCHAIRS



Artemide

GruppoFox Design



Daphne

GruppoFox Design



Diana

GruppoFox Design



Mirto
GruppoFox Design



Partenope

GruppoFox Design



Tecla

GruppoFox Design



Athena

GruppoFox Design



Hydra

GruppoFox Design



Kea
GruppoFox Design



Kea alta



Kea media



Kea bassa



Olympia

Gruppo Fox Design





Albertina

GruppoFox Design



Arrighina

GruppoFox Design



Charlotte

GruppoFox Design



Parigi

GruppoFox Design



Fanny

GruppoFox Design



Lapalla

GruppoFox Design





Linda

GruppoFox Design





Margot

GruppoFox Design



Milady

GruppoFox Design



Susanna

GruppoFox Design



Pouff

GruppoFox Design



SCHEDE TECNICHE
TECHNICAL SHEETS

Duepuntozero	pag. 314
Grecale	pag. 316
Link	pag. 318
Levante	pag. 320
Levante Air	pag. 322
Boss	pag. 324
Now Soft	pag. 328
Slaid	pag. 334
Hugo	pag. 336
Gran Milano	pag. 338
Hector	pag. 340
Alexis	pag. 344
Amalfi	pag. 346
Albert	pag. 350
Alpha	pag. 352
Infinity Soft	pag. 354
Metropolitan	pag. 358
Asso	pag. 360
Arrigo	pag. 362
Simon	pag. 364
Brad	pag. 366
Artemide	pag. 368
Mirto	pag. 369
Daphne	pag. 370
Diana	pag. 372
Partenope	pag. 374
Tecla	pag. 376
Athena	pag. 378
Hydra	pag. 379
Kea	pag. 380
Olympia	pag. 381
Albertina	pag. 382
Arrighina	pag. 383
Charlotte	pag. 384
Parigi	pag. 385
Fanny	pag. 386
Lapalla	pag. 387
Linda	pag. 388
Margot	pag. 389
Milady	pag. 390
Susanna	pag. 391
Pouff	pag. 392
Ambrogio	pag. 394
Cassandra	pag. 395
Medusa	pag. 396
Perseo	pag. 398

Duepuntozero

Gruppo Fox Design

Caratteristiche Features



- Rivestimenti in tessuto completamente sfoderabili.
Fully removable fabric covers.
- Cuscini schienale in filpiuma (speciale miscela soffice ed ipoallergenica composta da vera piuma e fibra siliconata cava), il tutto ricoperto di tessuto in puro cotone a tenuta di piuma.
Back cushions in filpiuma (a special soft and hypoallergenic blend made up of real feather and hollow silicone fibre), all covered with feather-proof pure cotton fabric.
- Struttura in legno e derivati leggeri con imbottitura in poliuretano espanso il tutto rivestito in vellutino.
Structure in wood and light derivatives with polyurethane foam padding, all covered in velveteen.
- Sedute monoscocca in poliuretano espanso a quote differenziate accoppiate ad un trapuntino in dacron e rivestite in vellutino.
Single frame seat cushions in multi-density polyurethane foam coupled with a dacron quilt and upholstered in velveteen.
- Piedi a scomparsa in ABS nero con inserto antiscivolo.
Retractable feet in black ABS with non-slip insert.

Variazioni Variations

ATTENZIONE:

La particolare geometria del modello Duepuntozero dà ai vari elementi un ingombro laterale di 100 cm, ma l'ingombro totale del modello è di 110 cm, misurato dalla punta posteriore alle punte anteriori.

ATTENTION:

The particular geometry of the Duepuntozero model gives all models a lateral encumbrance of 100 cm, but the total encumbrance of the model is 110 cm, measured from the rear tip to the front tips.

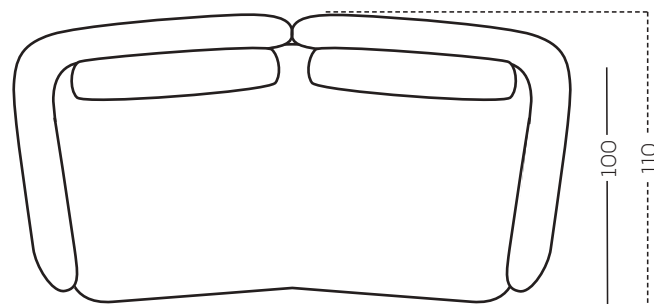

Elementi Elements

DPZCD220

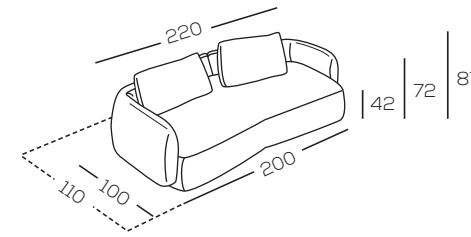

DPZCD260

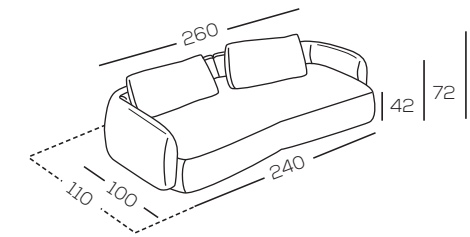

DPZCD300

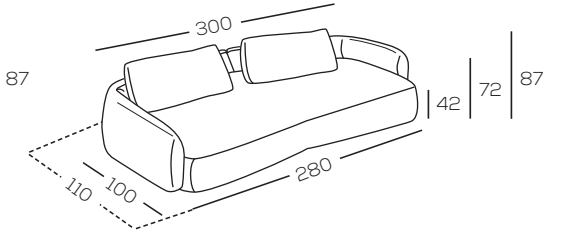

DPZCT110 Dx/Sx

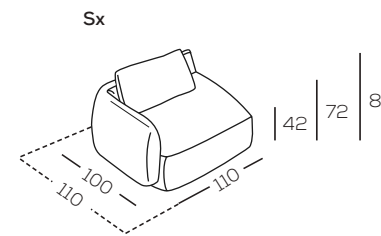

DPZCT130 Dx/Sx

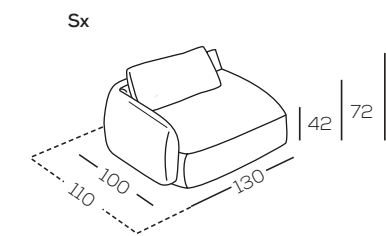

DPZCT150 Dx/Sx

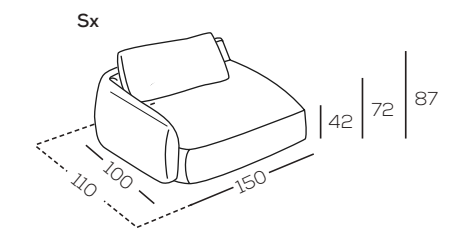

DPZCA130

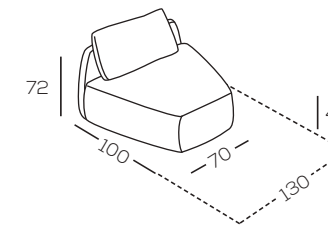

DPZCCSP145 Dx/Sx

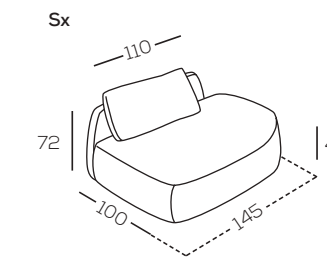

DPZCR210 Dx/Sx

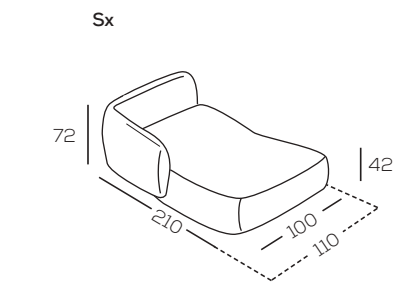

DPZCCS60

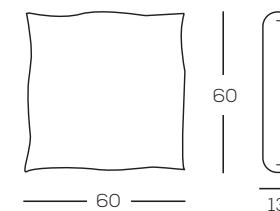

DPZCCS50

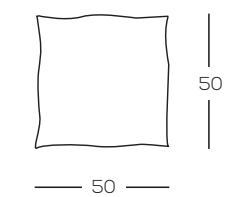

Grecale

Gruppo Fox Design

Caratteristiche
Features



- Rivestimenti in tessuto completamente sfoderabili.
Fully removable fabric covers.
- Cuscini schienale ultralight in poliuretano espanso con traverso interno in massello di abete per aiutarne la stabilità.
Ultralight back cushions in polyurethane foam with internal crosspiece in solid fir to help stability.
- Struttura in massello di abete e derivati leggeri con imbottitura in poliuretano espanso, il tutto rivestito in vellutino.
Structure in solid fir and light derivatives with polyurethane foam padding, all covered in velveteen.
- Sedute monoscocca in poliuretano espanso a quote differenziate rivestite in vellutino.
Single frame seat cushions in multi-density polyurethane foam covered in velveteen.
- Piedi a scomparsa in ABS nero con inserto antiscivolo.
Retractable feet in black ABS with non-slip insert.

Variazioni
Variations

ATTENZIONE:
La particolare geometria del modello Grecale dà alle basi 200, 240 e 280 un ingombro laterale di 115 cm, ma l'ingombro totale del modello è di 125 cm, misurato dalla punta posteriore alle punte anteriori.

ATTENTION:
The particular geometry of the Grecale model gives the 200, 240 and 280 base units a lateral encumbrance of 115 cm, but the total encumbrance of the model is 125 cm, measured from the rear tip to the front tips.

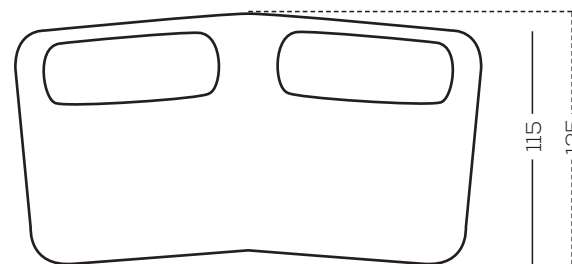

Elementi
Elements

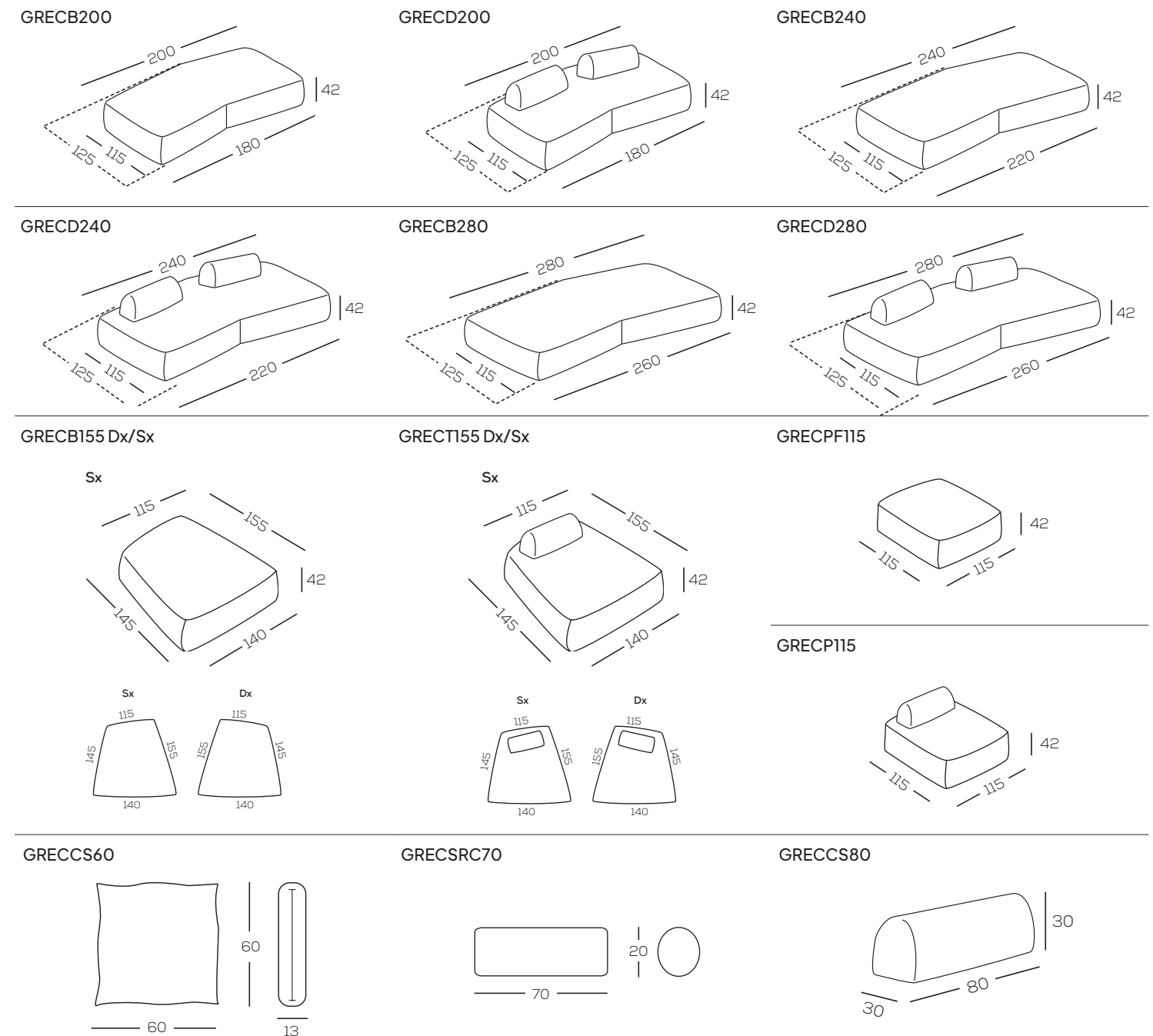

Link

Gruppo Fox Design

Caratteristiche Features



- Rivestimenti in tessuto completamente sfoderabili. Profili in tessuto in tinta o in contrasto.
Fully removable fabric covers. Profiles in matching or contrasting fabric.
- Cuscini schienale in vera piuma, con inserto in espanso morbido, ricoperti in tessuto di puro cotone a tenuta di piuma.
Back cushions in real feather, with insert in soft foam, covered in feather-tight pure cotton fabric.
- Struttura in multistrato e derivati legno, rivestita in poliuretano espanso, il tutto rivestito in vellutino.
Structure in plywood and wood derivatives, covered in polyurethane foam, all covered in velvet.
- Cuscini seduta in poliuretano espanso a quote differenziate rivestito con un trapuntino in vera piuma, il tutto ricoperto di puro cotone a tenuta di piuma.
Seat cushions in differentiated-density polyurethane foam covered with a real feather quilt, all covered in pure feather-tight cotton.
- Piedi a vista conici (diametro da mm 30 a mm 15) in fusione di alluminio nella finitura lucida o verniciata bronzo.
Conical visible feet (diameter from 30 mm to 15 mm) in cast aluminum in polished or bronze painted finish.

Variazioni Variations



PIEDI CONICI IN FUSIONE DI ALLUMINIO
CONICAL CAST ALUMINUM FEET



PIEDI CILINDRICI IN ACCIAIO
CYLINDRICAL STEEL FEET

A richiesta sono disponibili piedi a vista cilindrici (diametro mm 20) in acciaio disponibili nella finitura cromata lucida o verniciata bronzo. Si prega di specificare le finiture al momento dell'ordine.

Upon request cylindrical exposed feet (diameter 20 mm) in steel are available in polished chrome or bronze painted finish. Please specify finishings upon order.



A richiesta e con una maggiorazione, viene eseguita solo per le pelli una particolare cucitura con finitura "taglio a vivo". Si prega di specificare le finiture al momento dell'ordine.

Upon request and with a price increase, it is carried out only for leathers a particular stitching with "raw cut" finish. Please specify the finishes when ordering.

Profili in tessuto in tinta o in contrasto. Su richiesta e senza maggiorazione è possibile ordinare il divano senza i profili sulla cuscinatura di seduta. Si prega di specificare le finiture al momento dell'ordine. Le imbottiture in piuma conferiranno al divano un aspetto più destrutturato e vissuto, le forme dei cuscini diverranno quindi più morbide.

Profiles in matching or contrasting fabric. Upon request, and with no price increase, it is possible to order the sofa without sewn profiles on seat cushions. Please specify finishings upon order. The feather padding will give the sofa a more unstructured and worn look, the shapes of the cushions will therefore become softer.

Elementi Elements

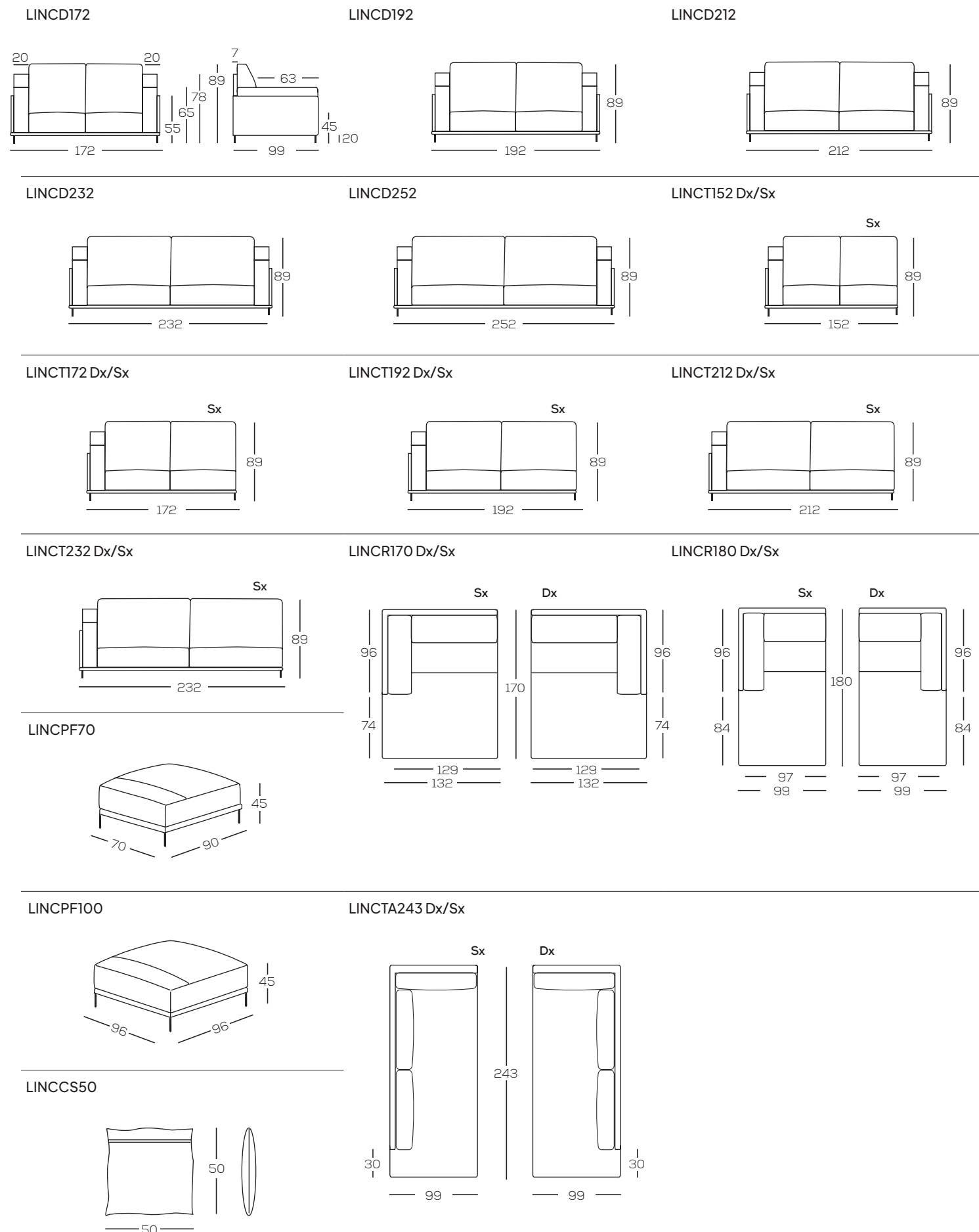

Levante

Gruppo Fox Design

Caratteristiche
Features



- Rivestimenti in tessuto completamente sfoderabili. Profili sempre in cannetè, in tinta o in contrasto.
Fully removable fabric covers. Profiles always in cannetè, matching or contrasting.
- Cuscini schienale in poliuretano espanso con base in legno inserita per aiutarne la staticità.
Back cushions in polyurethane foam with inserted wooden base to help its static.
- Struttura in legno e derivati leggeri con imbottitura in poliuretano espanso, il tutto rivestito in vellutino.
Structure in wood and light derivatives with padding in polyurethane foam, all covered in velvet.
- Sedute monoscocca trapuntate in poliuretano espanso a quote differenziate accoppiato ad un trapuntino in piuma, il tutto ricoperto di tessuto in puro cotone a tenuta di piuma.
Monocoque quilted seats in differentiated-density polyurethane foam coupled with a feather quilt, all covered in feather-tight pure cotton fabric.
- Piedi a scomparsa in ABS nero con inserto antiscivolo.
Invisible feet in black ABS with non-slip insert.

Variazioni
Variations

Profili sempre in cannetè, in tinta o in contrasto.
Si prega di specificare le finiture al momento dell'ordine.

*Profiles always in cannetè stitching, matching or contrasting.
Please specify the finishes upon ordering.*

Elementi
Elements

LEVCB204

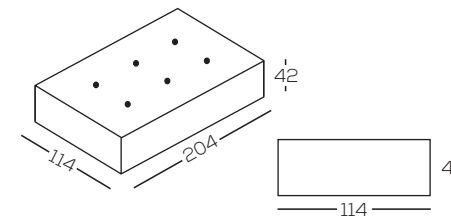

LEVCD204

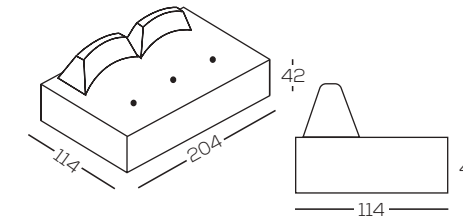

LEVCB224

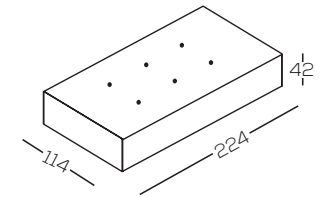

LEVCD224

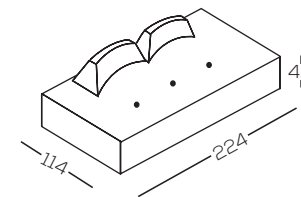

LEVCB244

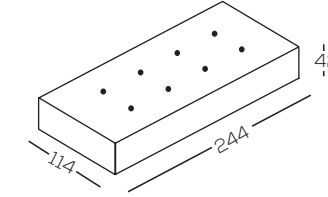

LEVCD244

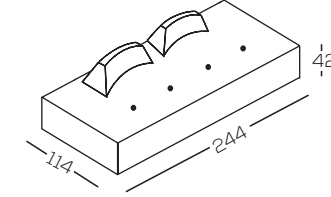

LEVCB264

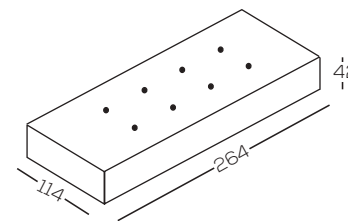

LEVCD264

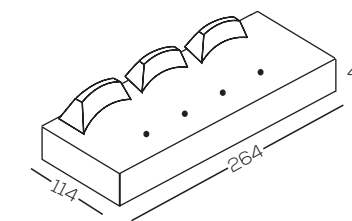

LEVCA114

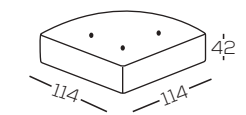

LEVCPF114

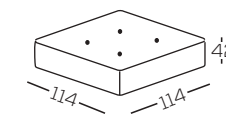

LEVCCS75

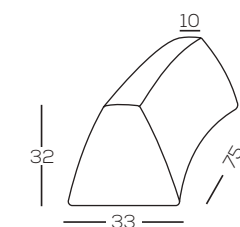

LEVCCSF60

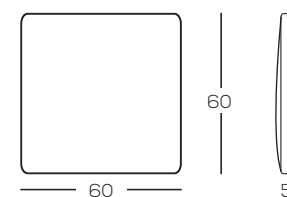

LEVCCS40

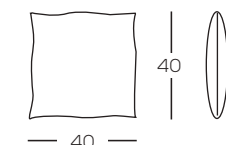

LEVCPR50

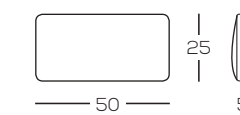

Levante Air

Gruppo Fox Design

Caratteristiche Features



• Rivestimenti in tessuto completamente sfoderabili. Profili sempre in cannetè, in tinta o in contrasto.
Fully removable fabric covers. Profiles always in cannetè, matching or contrasting.

• Cuscini schienale in poliuretano espanso con base in legno inserita per aiutarne la staticità.
Back cushions in polyurethane foam with inserted wooden base to help its static.

• Struttura in legno e derivati leggeri con imbottitura in poliuretano espanso, il tutto rivestito in vellutino.
Structure in wood and light derivatives with polyurethane foam padding, all covered in velvet.

• Sedute monoscocca trapuntate in poliuretano espanso a quote differenziate accoppiato ad un trapuntino in piuma, il tutto ricoperto di tessuto in puro cotone a tenuta di piuma.
Monocoque quilted seats in differentiated-density polyurethane foam coupled with a feather quilt, all covered in feather-tight pure cotton fabric.

• Piedi a vista in alluminio disponibili nella finitura bronzata o lucida.
Exposed feet in aluminum available in bronze or glossy finish.

Variazioni Variations

Profili sempre in cannetè, in tinta o in contrasto.
Si prega di specificare le finiture al momento dell'ordine.

*Profiles always in cannetè stitching, matching or contrasting.
Please specify the finishes upon ordering.*



H. 16,5 CM

PIEDI A VISTA IN ALLUMINIO
EXPOSED FEET IN ALUMINUM



H. 15,5 CM

PIEDINI A PONTE IN FUSIONE DI ALLUMINIO
BRIDGE FEET IN CAST ALUMINUM

A richiesta sono disponibili piedini a ponte in fusione di alluminio nella finitura bronzata con sovrapprezzo.
Si prega di specificare le finiture al momento dell'ordine.

*Upon request bridge feet in cast aluminum in bronze finish are available with a price rise.
Please specify finishings upon order.*

Elementi Elements

LEACB204

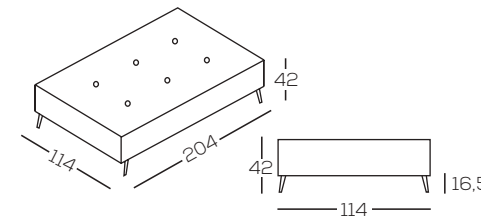

LEACD204

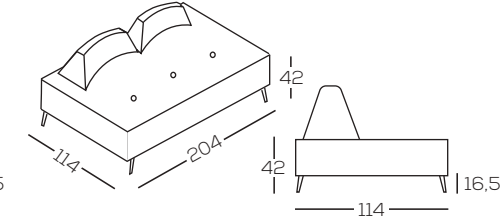

LEACB224

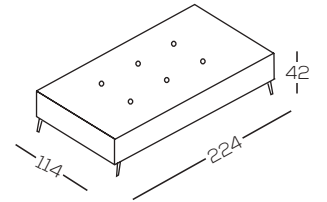

LEACD224

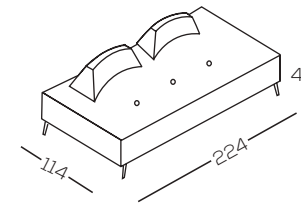

LEACB244

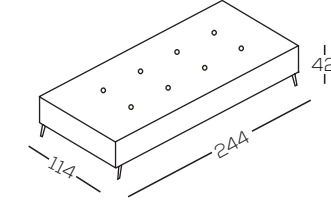

LEACD244

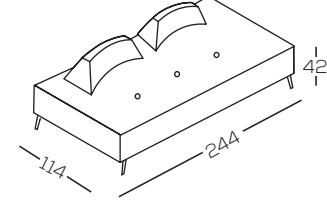

LEACB264

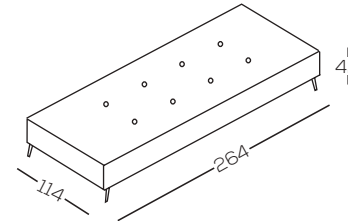

LEACD264

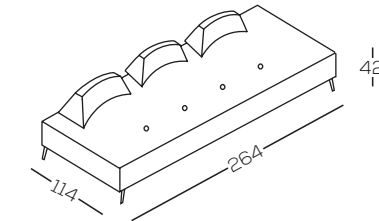

LEACA114

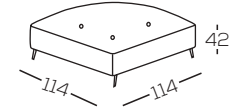

LEACPF114

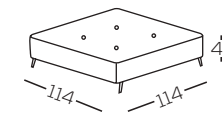

LEACCS75

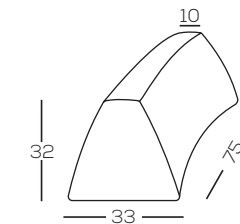

LEACCSF60

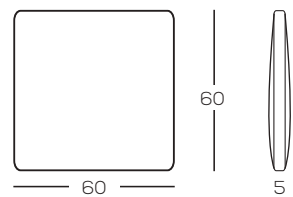

LEACCS40

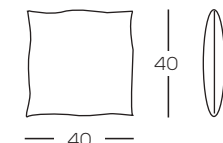

LEACPR50

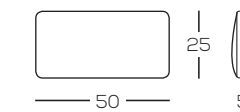

Boss

Gruppo Fox Design

Caratteristiche Features



- Rivestimenti in tessuto completamente sfoderabili.
Fully removable fabric covers.
- Cuscini schienale in filpiuma (speciale miscela soffice ed ipoallergenica composta da vera piuma e fibra siliconata cava), il tutto ricoperto di tessuto in puro cotone a tenuta di piuma.
Back cushions in filpiuma (special soft and hypoallergenic mixture composed of real feather and hollow silicone fiber), all covered in pure cotton fabric with feather hold.
- Sedute monoscocca in poliuretano espanso a quote differenziate accoppiato ad un trapuntino in piuma, il tutto ricoperto di tessuto in puro cotone a tenuta di piuma.
Monocoque seats in differentiated-density polyurethane foam coupled with a feather quilt, all covered in feather-tight pure cotton fabric.
- Struttura in legno e derivati leggeri con imbottitura in poliuretano espanso, il tutto rivestito in vellutino.
Structure in wood and derivatives with polyurethane foam padding, all covered in velvet.
- Piedi a scomparsa in ABS nero con inserto antiscivolo.
Invisible feet in black ABS with non-slip insert.

Variazioni Variations

Per un corretto utilizzo i divani devono essere completati con i cuscini di schienale oppure con i cuscinetti accessori. Le cuciture praticate di serie su questo modello sono: taglio vivo (pelle), pizzicata (tessuto) e profilo in canneté in tinta o a contrasto (velluto).

A richiesta e senza maggiorazione, viene praticata una cucitura a costina che rende i rivestimenti più abbondanti, per un aspetto e una seduta più soffice e destrutturata.

Le imbottiture in piuma conferiranno al divano un aspetto più destrutturato e vissuto, le forme dei cuscini diverranno quindi più morbide.

For a correct use, the sofas must be completed with back cushions or with accessory cushions. The standard stitching on this model is: raw cut (leather), plucked (fabric) and canneté profile in the same or contrasting color (velvet).

Upon request and without price increase, a rib stitching is practiced which makes the coverings more abundant, for a softer and more unstructured appearance and seating.

The feather padding will give the sofa a more unstructured and worn look, the shapes of the cushions will therefore become softer.

Elementi Elements

BO1CC75 prof/depth 100

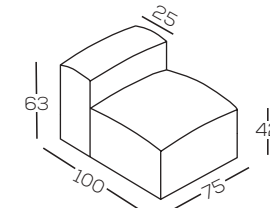

BO1CC100 prof/depth 100

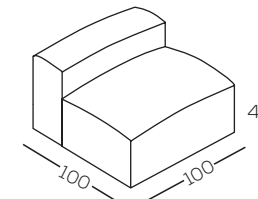

BO1CC125 prof/depth 100

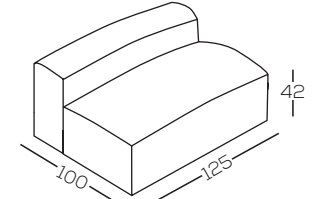

BO1CC150 prof/depth 100

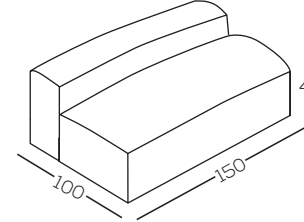

BO2CC75 prof/depth 125

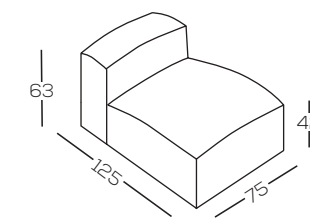

BO2CC100 prof/depth 125

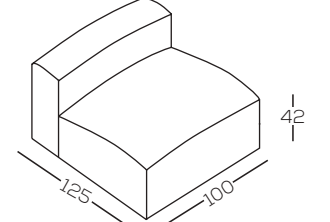

BO2CC125 prof/depth 125

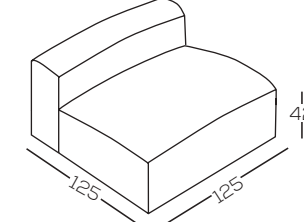

BO2CC150 prof/depth 125

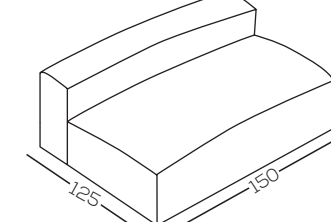

BO1CBR25A prof/depth 100

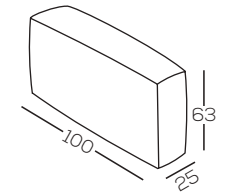

BO1CBR25B prof/depth 100

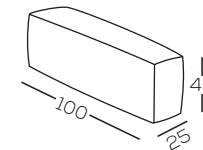

BO1CBR40A prof/depth 100

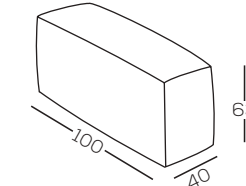

BO1CBR40B prof/depth 100

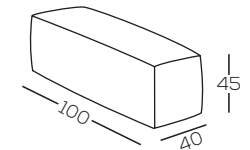

BO2CBR25A prof/depth 125

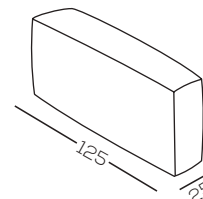

BO2CBR25B prof/depth 125

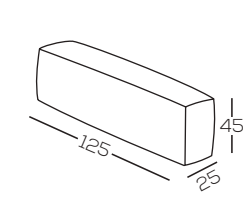

BO2CBR40A prof/depth 125

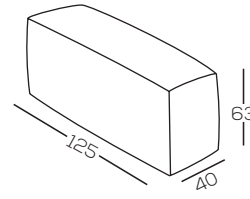

BO2CBR40B prof/depth 125

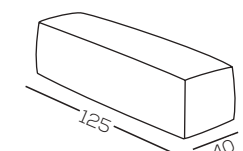

BOSCPF75

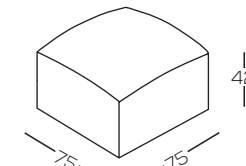

BOSCPF10075

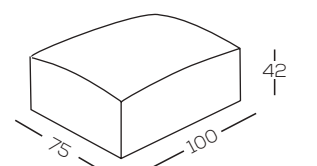

BOSCPF12575

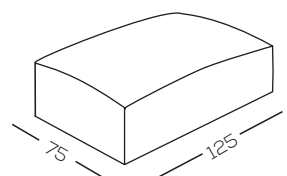

BOSCPF100

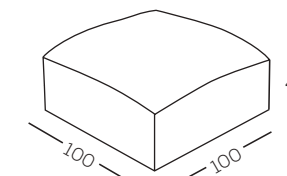

Elementi
Elements

BOSCPF125

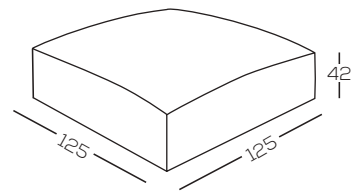

BOSCPF125100

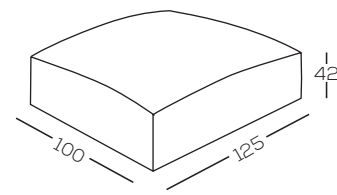

BO1CR200 Dx/Sx

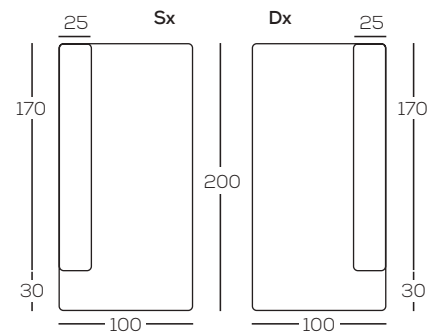

BO2CR200 Dx/Sx

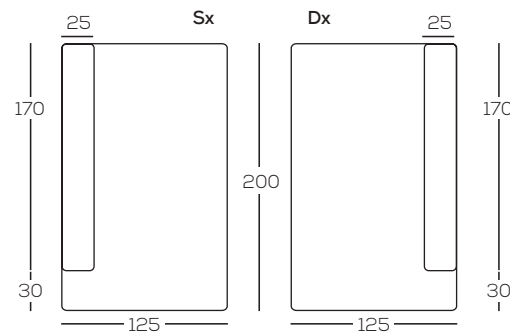

BO1CR225 Dx/Sx

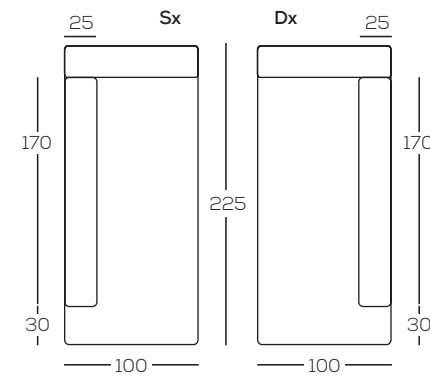

BO2CR225 Dx/Sx

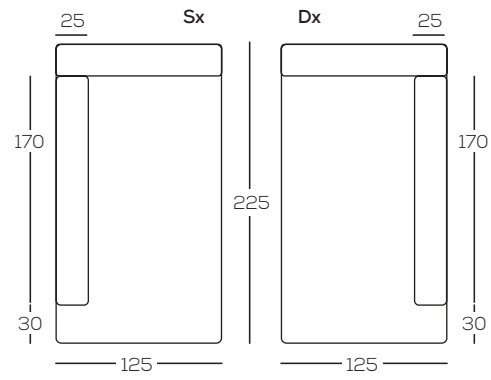

Cuscini di schienale
Back cushions

BOSCCS70

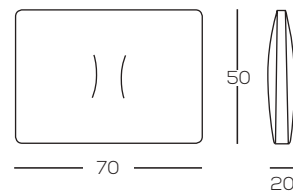

BOSCCS95

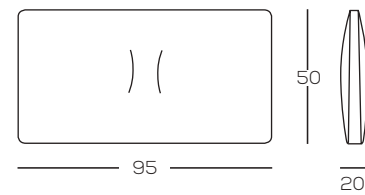

BOSCCS120

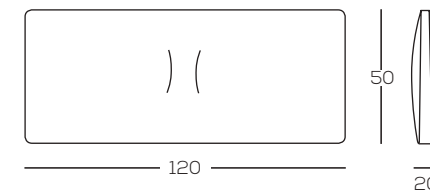

Now Soft

Gruppo Fox Design

Caratteristiche

Features

- Rivestimenti in tessuto completamente sfoderabili.
Fully removable fabric covers.
- Cuscini schienale in piuma, marchio ORO ASSOPIUMA, dotati di rullo di sostegno in poliuretano espanso, ricoperti in tessuto di puro cotone a tenuta di piuma..
Back cushions in ORO ASSOPIUMA branded feather, equipped with support roller in polyurethane foam, covered in feather-tight pure cotton fabric.
- Struttura in legno e derivati con molleggio a cinghie elastiche ed imbottitura in poliuretano espanso, il tutto rivestito in vellutino bianco.
Structure in wood and derivatives with springing with elastic belts and padding in polyurethane foam, all covered in white velvet.
- Cuscini seduta in piuma, marchio ORO ASSOPIUMA, con inserto in poliuretano espanso, ricoperti in tessuto di puro cotone a tenuta di piuma.
Seat cushions in ORO ASSOPIUMA branded feather, with polyurethane foam insert, covered in feather-tight pure cotton fabric.
- Piedi a vista in legno, cm 22x22, disponibili nella finitura wengé, noce, ciliegio e faggio naturale
Visible wooden feet, 22x22 cm, available in wengé, walnut, cherry and natural beech finish



PROFONDITA' 100CM
DEPTH 100CM

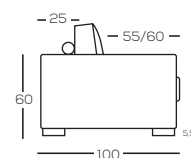

PROFONDITA' 120CM
DEPTH 120CM

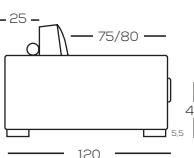

Variazioni

Variations



PIEDI A VISTA IN LEGNO
VISIBLE WOODEN FEET



PIEDI IN TUBOLARE
METALLICO
METAL TUBULAR FEET

- A richiesta sono disponibili piedi in tubolare metallico cromato, con maggiorazione.
Si prega di specificare le finiture al momento dell'ordine.

*• Upon request chromed metal tubular feet are available with a price rise.
Please specify finishings upon order.*



A richiesta e con maggiorazione viene eseguita (solo per tessuti) una particolare cucitura rovesciata, con sorfilo a vista, sia in tinta che in contrasto.

Si prega di specificare le finiture al momento dell'ordine.

*Upon request and with a price increase a particular upside-down stitching is performed (only for fabrics), with visible overcasting, both in color and in contrast.
Please specify finishings upon order.*

Variazioni

Variations

Le composizioni angolari si ottengono accostando semplicemente tra loro i vari elementi.

Per questo modello è prevista la possibilità di apportare modifiche sartoriali e/o dimensionali.

A richiesta senza maggiorazioni, cuscini schienale e/o cuscini seduta possono essere realizzati esclusivamente con poliuretani espansi indeformabili. Richiedere preventivi ai nostri uffici commerciali.

Le imbottiture in piuma conferiranno al divano un aspetto più destrutturato e vissuto, le forme dei cuscini diverranno quindi più morbide.

The angular compositions are obtained by simply combining the various elements together.

For this model it is possible to make sartorial and / or dimensional changes.

Upon request and without surcharges, back cushions and/or seat cushions can be made exclusively with non-deformable polyurethane foam. Please request quotes from our sales offices.

The feather padding will give the sofa a more unstructured and worn look, the shapes of the cushions will therefore become softer.

Elementi

Elements

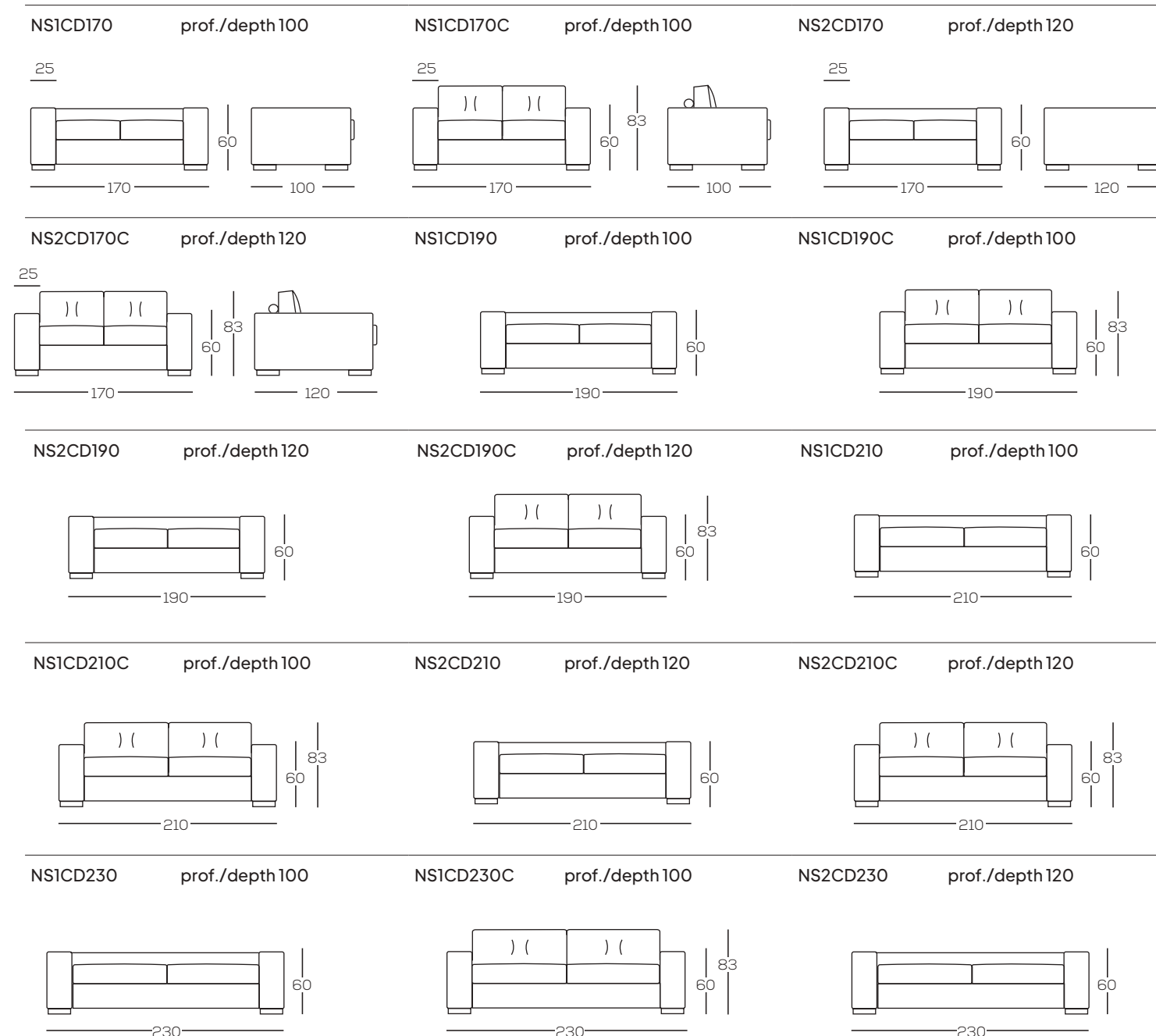

Elementi
Elements

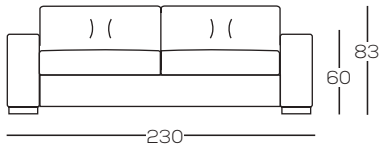
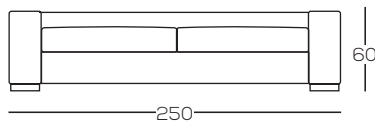
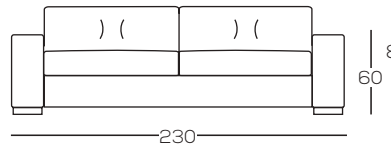
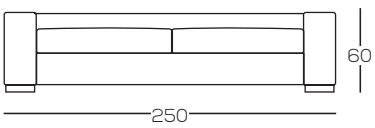
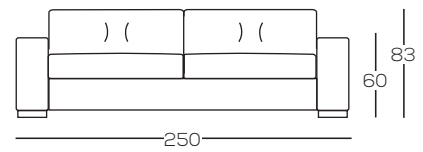
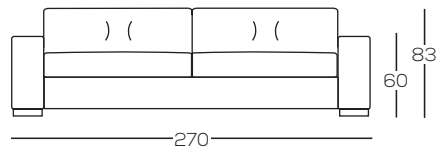
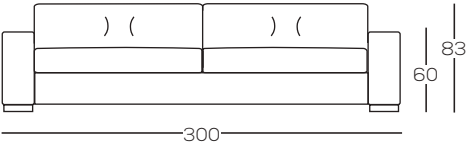
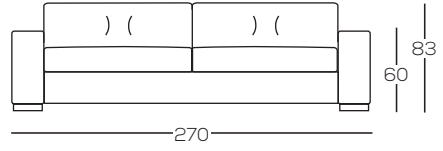
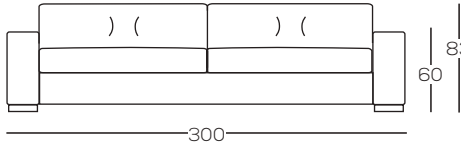
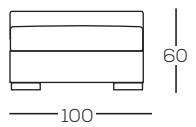
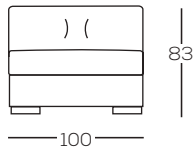
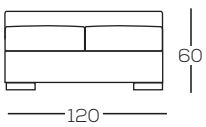
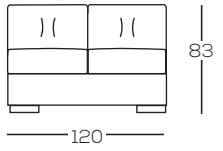
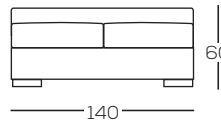
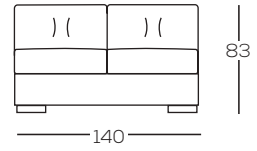
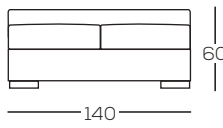
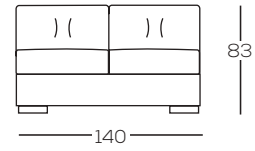
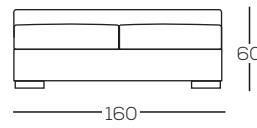
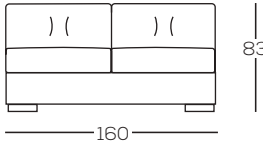
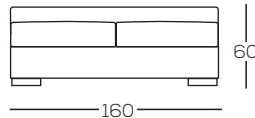
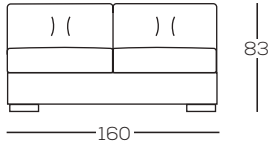
NS2CD230C prof./depth 120 	NS1CD250 prof./depth 100 	NS1CD250C prof./depth 100 
NS2CD250 prof./depth 120 	NS2CD250C prof./depth 120 	NS1CD270C prof./depth 100 
NS1CD300C prof./depth 100 	NS2CD270C prof./depth 120 	NS2CD300C prof./depth 120 
NS1CC100 prof./depth 100 	NS1CC100C prof./depth 100 	NS1CC120 prof./depth 100 
NS1CC120C prof./depth 100 	NS1CC140 prof./depth 100 	NS1CC140C prof./depth 100 
NS2CC140 prof./depth 120 	NS2CC140C prof./depth 120 	NS1CC160 prof./depth 100 
NS1CC160C prof./depth 100 	NS2CC160 prof./depth 120 	NS2CC160C prof./depth 120 

Elementi
Elements

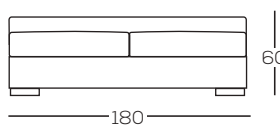
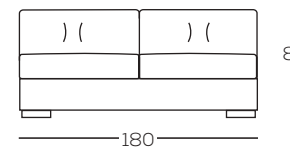
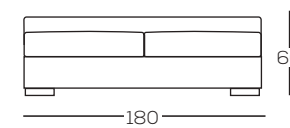
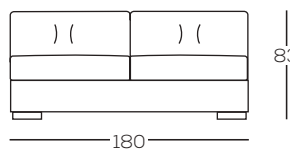
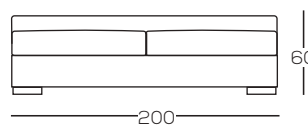
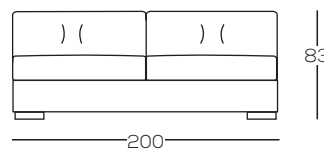
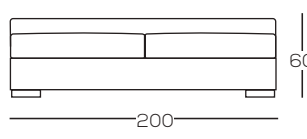
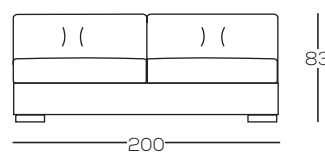
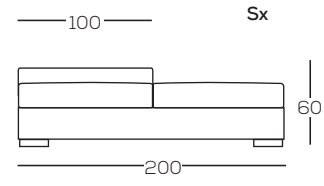
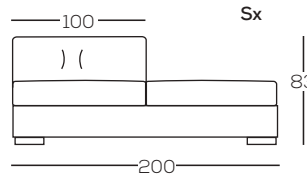
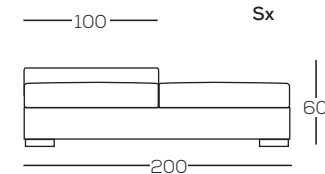
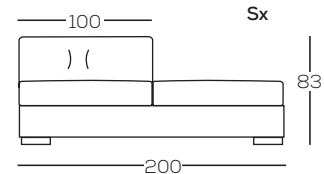
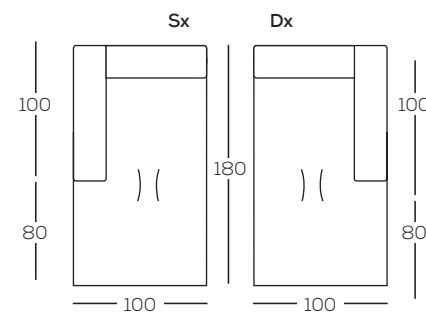
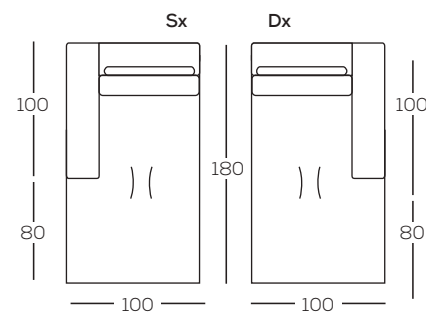
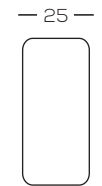
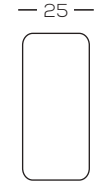
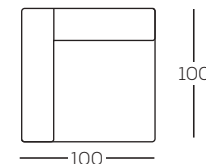
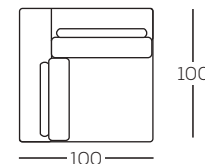
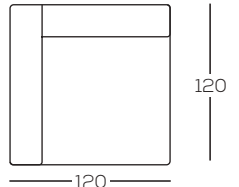
NS1CC180 prof./depth 100 	NS1CC180C prof./depth 100 	NS2CC180 prof./depth 120 
NS2CC180C prof./depth 120 	NS1CC200 prof./depth 100 	NS1CC200C prof./depth 100 
NS2CC200 prof./depth 120 	NS2CC200C prof./depth 120 	NS1CCSP200 Dx/Sx prof./depth 100 
NS1CCSP200C Dx/Sx prof./depth 100 	NS2CCSP200 Dx/Sx prof./depth 120 	NS2CCSP200C Dx/Sx prof./depth 120 
NS1CR180 Dx/Sx 	NS1CR180C Dx/Sx 	NS1CBR prof./depth 100 
		NS2CBR prof./depth 120 
NS1CA100 	NS1CA100C 	NS2CA120 

Elementi
Elements

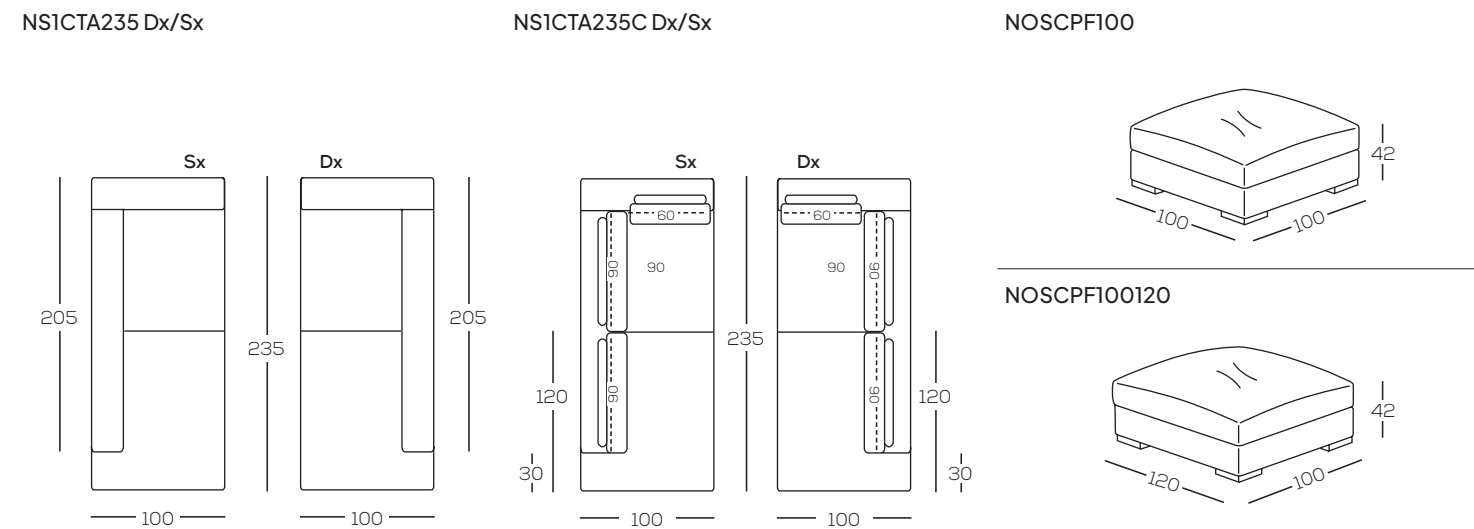
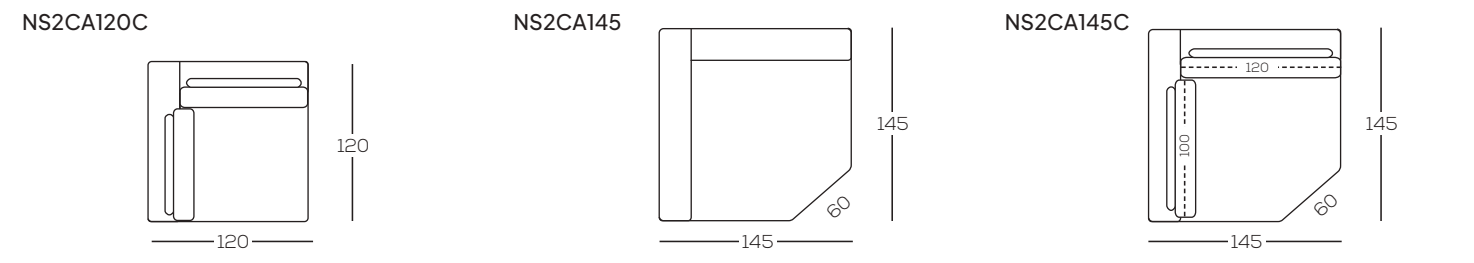

Kit cuscini
Pillow kit

Kit cuscini
Pillow kit

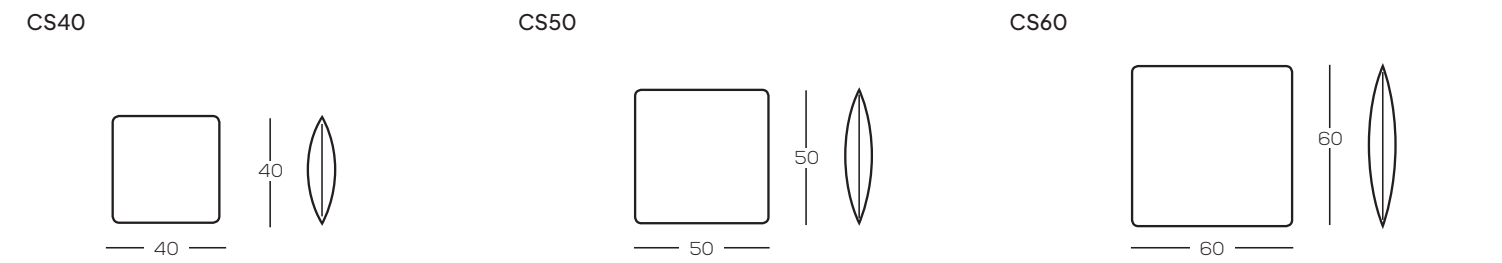

Cuscini singoli schienale
Single backrest pillows

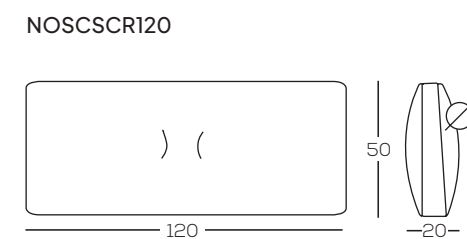
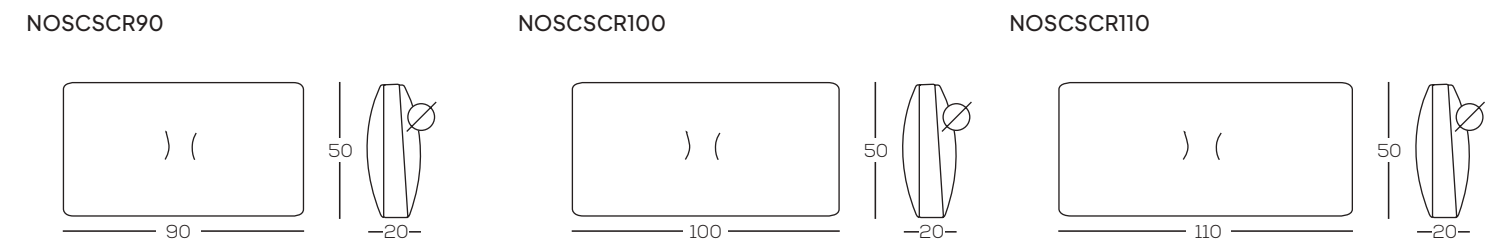
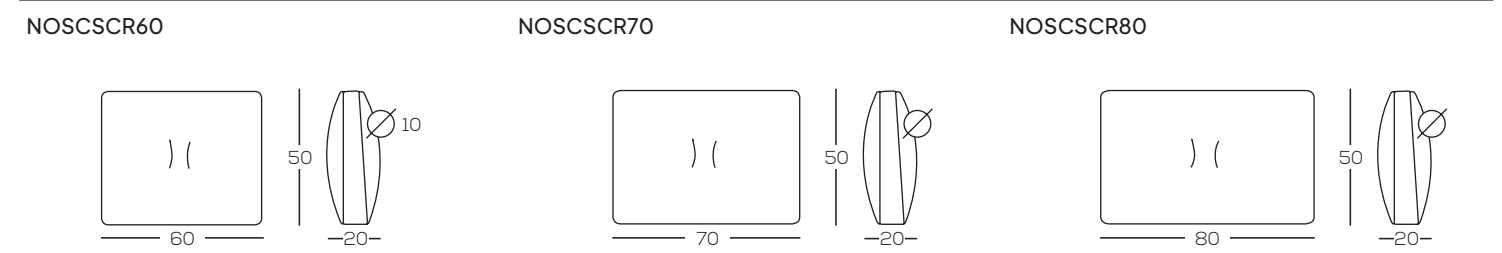

Slaid

Gruppo Fox Design

Caratteristiche Features



- Rivestimenti in tessuto completamente sfoderabili con cuciture pizzicate.
Fully removable fabric covers with pinched seams.
- Cuscini schienale in FILPIUMA (speciale miscela sofficie e ipoallergenica composta da vera piuma e fibra siliconata cava), il tutto ricoperto in tessuto a tenuta di piuma.
Back cushions in FILPIUMA (special soft and hypoallergenic mixture composed of real feather and hollow silicone fiber), all covered in feather-tight fabric.
- Struttura in legno massello e derivati leggeri con molleggio a cinghie elastiche ed imbottitura in poliuretano espanso, il tutto rivestito in vellutino.
I divani hanno inserti in metallo per via dei meccanismi necessari all'avanzamento delle sedute.
Structure in solid wood and light derivatives with springing with elastic belts and padding in polyurethane foam, all covered in velvet.
The sofas have metal inserts because of the mechanisms necessary for the advancement of the seats.
- Sedute monoscocca in poliuretano espanso a quote differenziate con top in memory foam, rivestite in vellutino.
Monocoque seats in differentiated-density polyurethane foam, with memory foam top covered in velvet.
- Piedi non a vista h. cm 3,5 in faggio tinta wengè.
Feet not visible h. 3.5 cm in wengè-colored beech.

Variazioni Variations



- I rivestimenti in pelle sono realizzati con la finitura "taglio a vivo" inclusa nel prezzo.
The leather upholstery is made with the "raw cut" finish included in the price.

Il silenzioso meccanismo presente nelle sedute, permette a queste ultime un'escursione di 40 cm, facendo leva semplicemente con il proprio peso corporeo.

- con la seduta avanzata troviamo una soluzione relax, profonda e accogliente.
- con la seduta rientrata, invece, si crea una soluzione di conversazione o lettura.

The silent mechanism present in the seats allows the latter to extract 40 cm, simply leveraging with one's own body weight.

- with the advanced seat we find a relaxing, deep and welcoming solution.
- with the seat retracted, however, a conversation or reading solution is created.

Elementi Elements

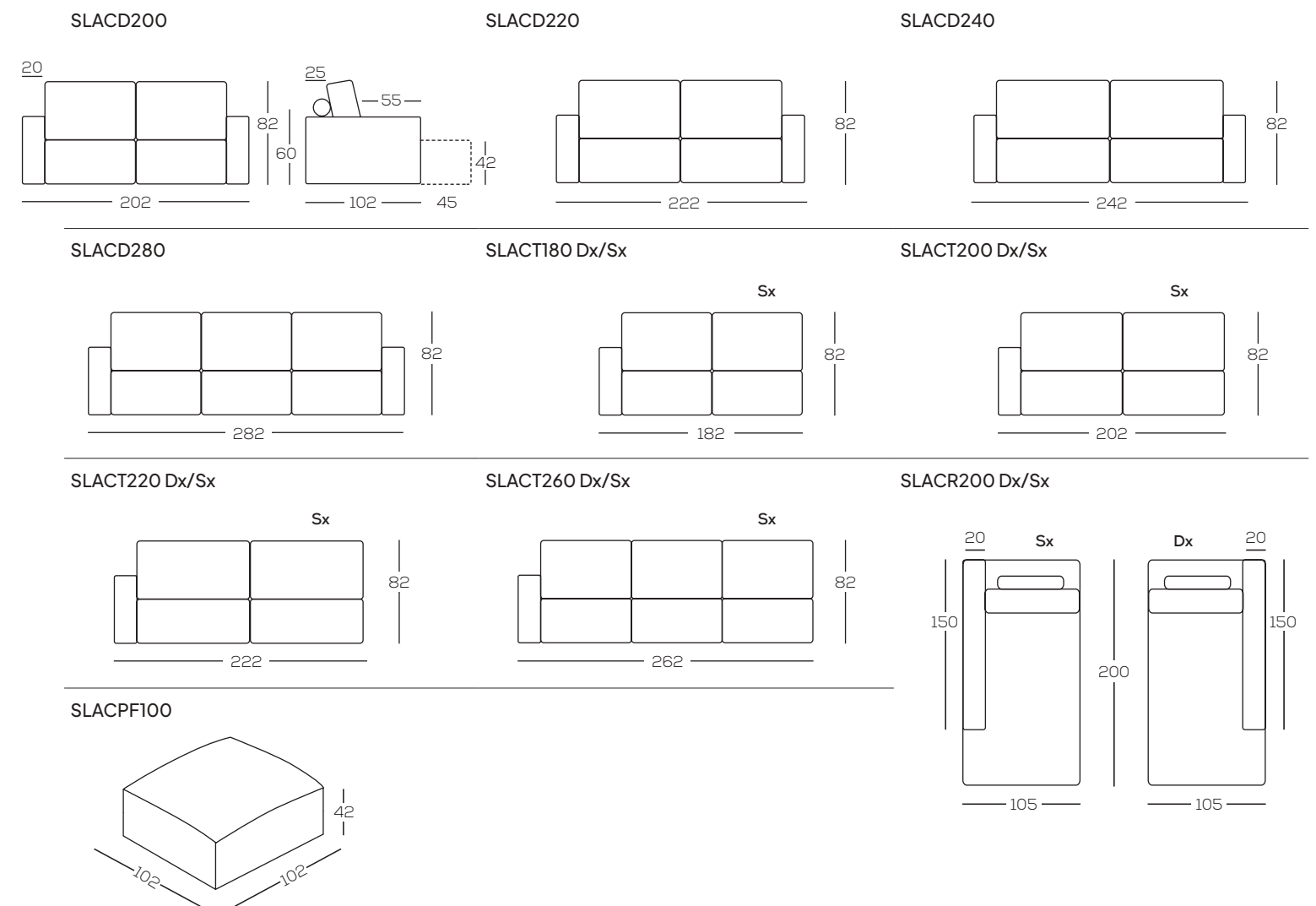

Hugo

Gruppo Fox Design

Caratteristiche Features



- Rivestimenti in tessuto completamente sfoderabili.
Fully removable fabric covers.
- Cuscini schienale in FILPIUMA (speciale miscela soffice e ipoallergenica composta da vera piuma e fibra siliconata cava), il tutto ricoperto in tessuto a tenuta di piuma.
Back cushions in FILPIUMA (special soft and hypoallergenic mixture composed of real feather and hollow silicone fiber), all covered in feather-tight fabric.
- Struttura in legno massello e derivati leggeri con imbottitura in poliuretano espanso, il tutto rivestito in vellutino.
Structure in solid wood and light derivatives with polyurethane foam padding, all covered in velveteen.
- Sedute monoscocca in poliuretano espanso a densità differenziate rivestite in vellutino.
Monocoque seats in polyurethane foam with differentiated densities covered in velvet.
- Piedi in fusione di alluminio bronzato h. 12cm
Feet in cast bronzed aluminum h. 12cm

Elementi Elements

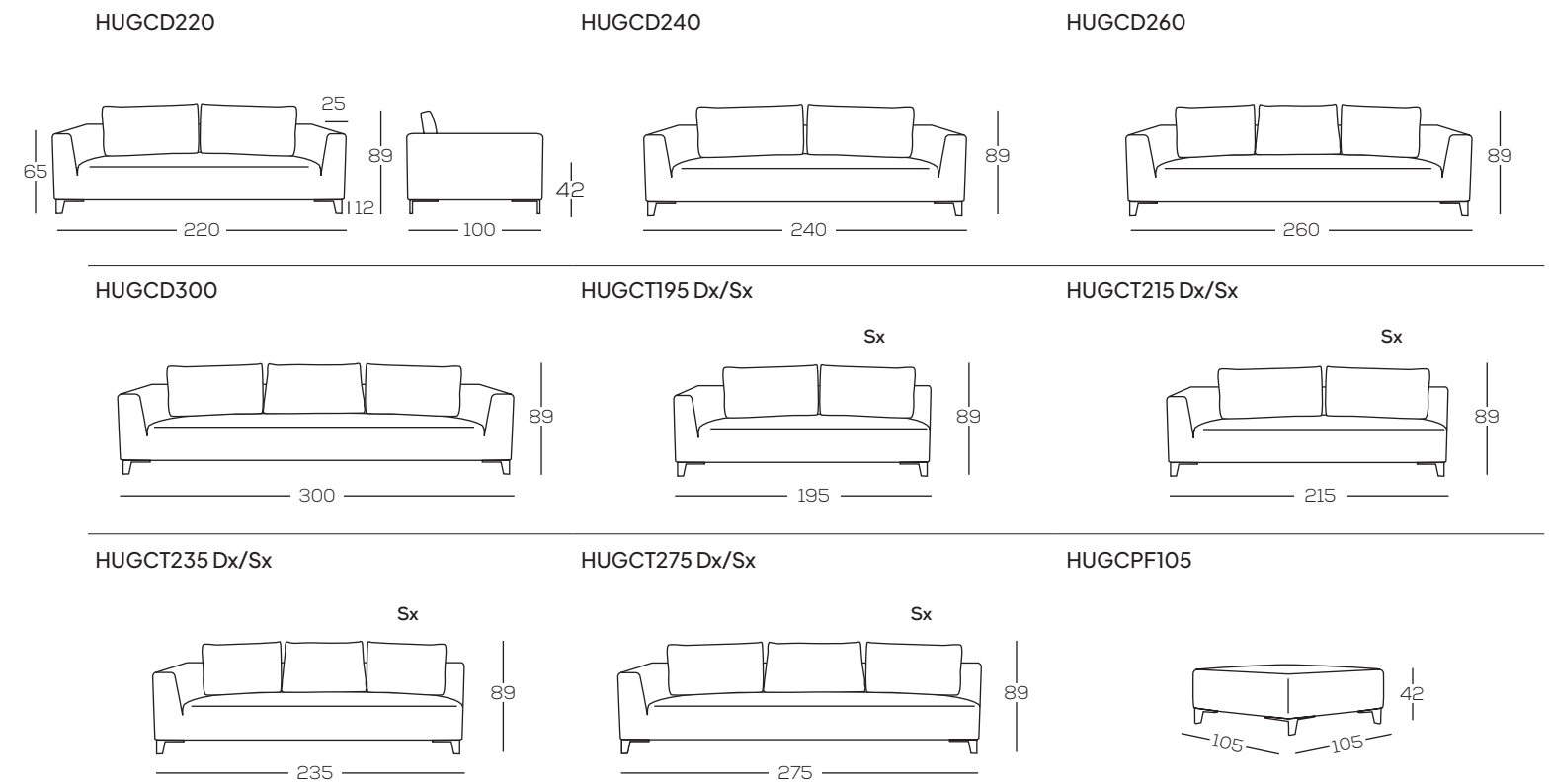

Gran Milano

Gruppo Fox Design

Caratteristiche Features



- Rivestimenti in tessuto completamente sfoderabili.
Fully removable fabric covers.
- Cuscini schienale in vera piuma canalizzata, garantita Assopiuma, ricoperti in tessuto in puro cotone a tenuta di piuma.
Back cushions in real canalized down, guaranteed Assopiuma, covered in pure downproof cotton fabric.
- Struttura in legno massello e derivati leggeri, con imbottitura in poliuretano espanso, il tutto rivestito in vellutino.
Structure in solid wood and light derivatives, with polyurethane foam padding, all covered in velveteen.
- Cuscini seduta in poliuretano espanso a densità differenziate con strato superficiale in memory foam, rivestiti in vellutino.
Seat cushions in polyurethane foam with different densities and with a surface layer of memory foam, covered in velveteen.
- Piedi in fusione di alluminio disponibili nella finitura bronzata.
Feet in cast aluminum available in bronzed finish.

Variazioni Variations



BRACCIOLLO STANDARD
STANDARD ARMREST



BRACCIOLLO TIPO B
TYPE B ARMREST

A richiesta e senza maggiorazioni è disponibile un bracciolo di tipo B con struttura interna inclinata e altezza uguale allo schienale, necessario come elemento di raccordo quando si creano composizioni angolari. Con queste soluzioni, verrà fornito anche un apposito cuscino schienale di raccordo, senza alcun sovrapprezzo.
Si prega di specificare le finiture al momento dell'ordine.

*Upon request and without surcharge, a type B armrest is available with an inclined internal structure and height equal to the backrest, necessary as a connecting element when creating corner compositions. With these solutions, a special padded connecting cushion will also be supplied, at no extra charge.
Please specify finishings upon order.*



PIEDI A SPILLO IN ALLUMINIO
PIN-SHAPED FEET IN ALUMINUM



PIEDI A L IN FUSIONE DI ALLUMINIO
L-SHAPED FEET IN CAST ALUMINUM

A richiesta sono disponibili piedi a L in fusione di alluminio, finitura bronzata, con supplemento.
Si prega di specificare le finiture al momento dell'ordine.

*Upon request L-shaped feet in cast aluminum, bronzed finish, are available with a price increase.
Please specify finishings upon order.*

Elementi Elements

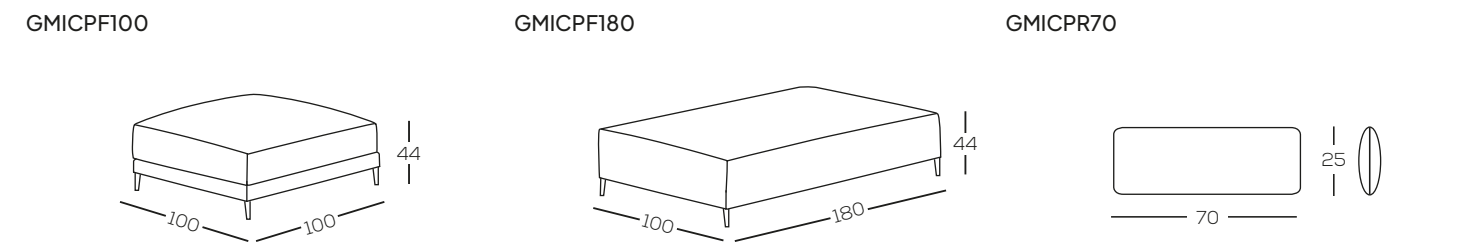
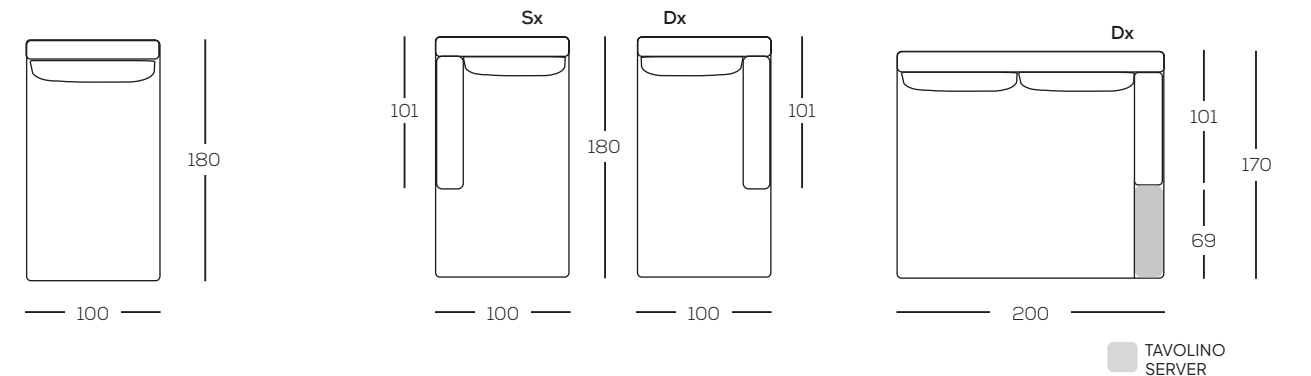
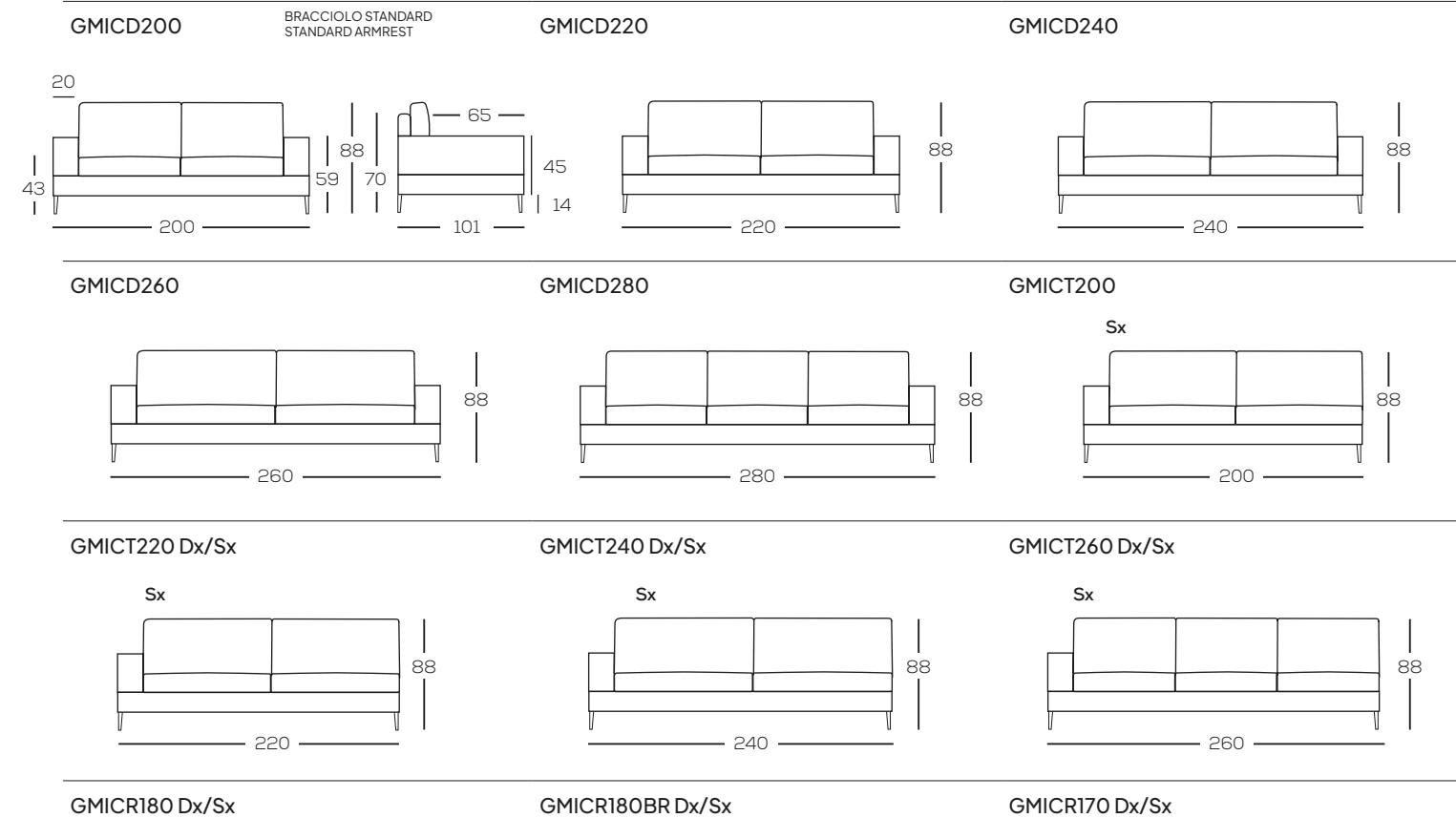

Hector

Gruppo Fox Design

Caratteristiche Features



- Rivestimenti in tessuto completamente sfoderabili.
Fully removable fabric covers.
- Cuscini schienale in filpiuma (speciale miscela soffice ed ipoallergenica composta da vera piuma e fibra siliconata cava).
Back cushions in filpiuma (special soft and hypoallergenic blend composed of real down and hollow silicone fiber).
- Struttura in massello di abete e derivati leggeri, con molleggio a cinghie elastiche. Imbottitura in poliuretano espanso e rivestimento in vellutino bianco. Schienale per movimento in ferro verniciato rivestito in espanso e fibra di poliestere accoppiata con poliuretano.
(Lo schienale con movimento consente di modificare la seduta da una posizione relax ad una di conversazione, 85cm - 65cm).
Structure in solid fir and light derivatives, with springing with elastic belts. Padding in polyurethane foam and covering in white velvet. Backrest for movement in painted iron covered in foam and polyester fiber coupled with polyurethane.
(The backrest with movement allows you to change the seat from a relaxation position to a conversation position, 85cm - 65cm).
- Cuscini seduta in poliuretano espanso a quote differenziate con trapuntino in vera piuma canalizzata ipoallergenica.
Seat cushions in polyurethane foam of different densities with quilt in real hypoallergenic canalized down.
- Piedi in fusione di alluminio bronzato h. 12cm
Feet in cast bronzed aluminum h. 12cm

Variazioni Variations

Il modello Hector si presenta originariamente senza braccioli.
E' possibile utilizzare il cuscino poggiatesta art. HECCPR70 sia come cuscino che come eventuale bracciolo.

*The Hector model is originally presented without armrests.
It is possible to use the backrest pillow art. HECCPR70 both as a cushion and as an optional armrest.*

Elementi Elements

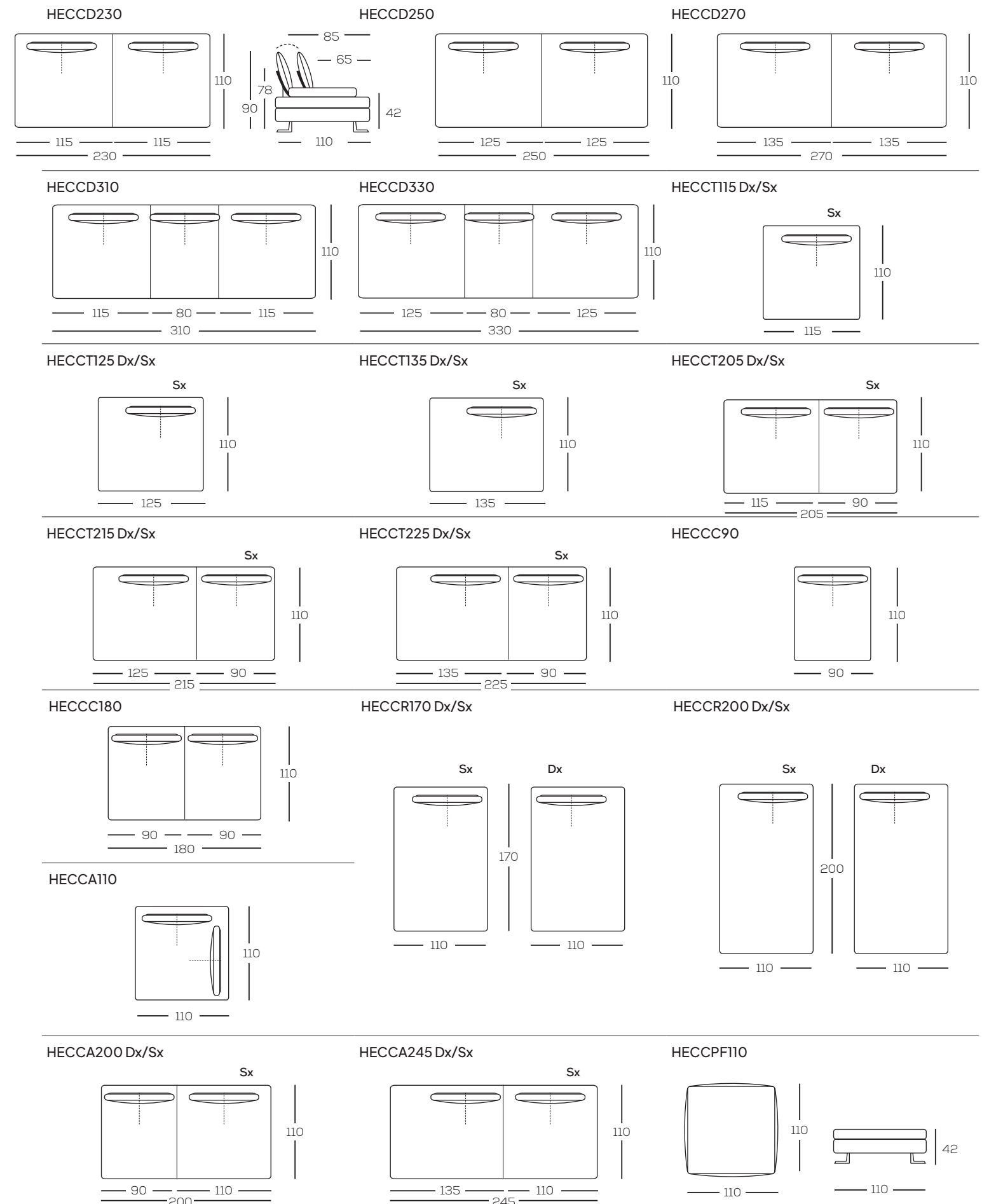

Elementi
Elements

HECCPR70

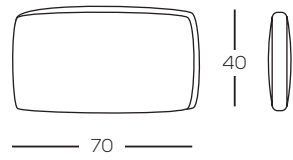
Variazioni
Variations

Il modello Hector si presenta originariamente senza braccioli.
E' possibile utilizzare il cuscino poggiatesta art. HECCPR70 sia come cuscino
che come eventuale bracciolo.

*The Hector model is originally presented without armrests.
It is possible to use the backrest pillow art. HECCPR70 both as a cushion
and as an optional armrest.*

A
BRACCIOLO
ARMRESTB
CUSCINO
PILLOW

Alexis

Gruppo Fox Design

Caratteristiche Features



- Rivestimenti in tessuto completamente sfoderabili.
Fully removable fabric covers.
- Cuscini schienale in FILPIUMA (speciale miscela soffice e ipoallergenica composta da vera piuma e fibra siliconata cava) con inserto in poliuretano espanso, il tutto ricoperto di tessuto a tenuta di piuma.
Back cushions in FILPIUMA (special soft and hypoallergenic mixture composed of real feather and hollow silicone fiber) with insert in polyurethane foam, all covered with feather-tight fabric.
- Struttura in legno e derivati con imbottitura in poliuretano espanso, il tutto rivestito in vellutino.
Structure in wood and derivatives with polyurethane foam padding, all covered in velvet.
- Cuscini seduta in poliuretano espanso (D30), accoppiato ad un trapuntino in vera piuma, il tutto ricoperto in tessuto a tenuta di piuma.
Seat cushions in polyurethane foam (D30), combined with a quilt in real feather, all covered in feather-proof fabric.
- Piedi singoli in metallo lucidato o bronzato oppure a slitta verniciati grigio medio opaco.
Single feet in polished or bronzed metal or sled painted matt medium gray.

Variazioni Variations



PIEDE SINGOLO IN METALLO
LUCIDATO O BRONZATO
SINGLE FOOT IN POLISHED OR
BRONZED METAL



PIEDE A SLITTA VERNICIATO GRIGIO
MEDIO OPACO
SLED FOOT PAINTED MATT MEDIUM
GRAY

Piedi singoli in metallo lucidato o bronzato oppure a slitta verniciati grigio medio opaco.

Si prega di specificare le finiture al momento dell'ordine.

*Single feet in polished metal or sled painted matt medium gray.
Please specify finishings upon order.*

Elementi Elements

ALECD194

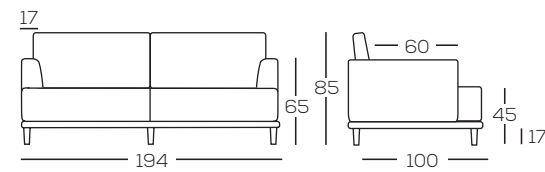

ALECD214

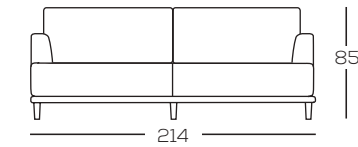

ALECD234

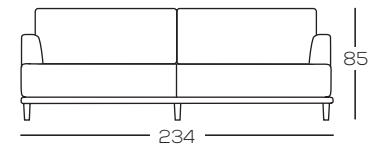

ALECT177 Dx/Sx

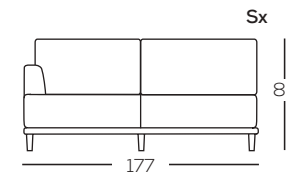

ALECT197 Dx/Sx

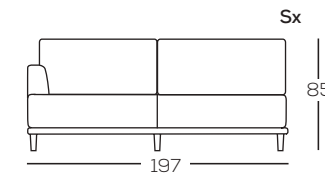

ALECT217 Dx/Sx

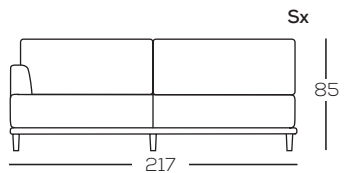

ALECR225 Dx/Sx

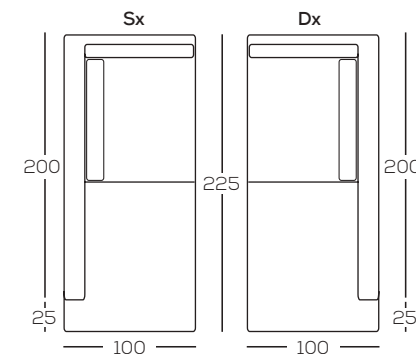

ALECPF100

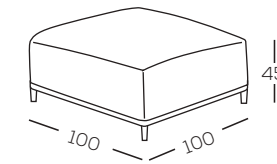

ALECCS40

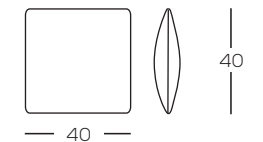

ALECCF50

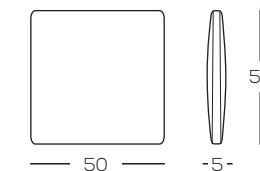

ALECCF80

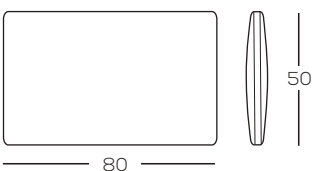

Amalfi

Gruppo Fox Design

Caratteristiche
Features



- Rivestimenti in tessuto completamente sfoderabili.
Fully removable fabric covers.
- Cuscini schienale in filpiuma (speciale miscela soffice ed ipoallergenica composta da vera piuma e fibra siliconata cava), il tutto ricoperto di tessuto in puro cotone a tenuta di piuma.
Back cushions in filpiuma (special soft and hypoallergenic mixture composed of real feather and hollow silicone fiber), all covered in feather-tight pure cotton fabric.
- Struttura in legno e derivati leggeri con molleggio a cinghie elastiche ed imbottitura in poliuretano espanso, il tutto rivestito in vellutino bianco.
Structure in wood and light derivatives with springing with elastic belts and padding in polyurethane foam, all covered in white velvet.
- Cuscini seduta in poliuretano espanso a quote differenziate con accoppiato un trapuntino in vera piuma, ricoperti di tessuto in puro cotone a tenuta di piuma.
Seat cushions in differentiated-density polyurethane foam with a real feather quilt, covered in feather-tight pure cotton fabric.
- Piedi non a vista h. cm 3,5 in faggio tinta wengè.
Feet not visible h. 3.5 cm in wengè-colored beech.

Variazioni
Variations



PIEDI NON A VISTA IN FAGGIO TINTA WENGÈ
NON VISIBLE FEET IN WENGÈ BEECH WOOD



PIEDI A VISTA IN FUSIONE DI ALLUMINIO
VISIBLE FEET IN CAST ALUMINUM

A richiesta piedi a vista h. cm 3,5 in fusione di alluminio disponibili nella finitura lucida o bronzata.
Si prega di specificare le finiture al momento dell'ordine.

*Upon request, 3.5 cm viewable feet in cast aluminum available in glossy or bronze finish.
Please specify finishings upon order.*

A richiesta, divani ed elementi centrali si possono avere con monocuscino di seduta senza maggiorazioni. Le composizioni angolari si ottengono anche senza l'utilizzo degli elementi angolari, semplicemente accostando tra loro i vari elementi. Con questa soluzione verrà fornito un apposito cuscino di schienale di raccordo, senza alcun sovrapprezzo. Le imbottiture in piuma conferiranno al divano un aspetto più destrutturato e vissuto, le forme dei cuscini diverranno quindi più morbide.

Upon request, sofas and central elements can be ordered with single-seat pillow with no surcharge. The corner compositions are obtained even without the use of the corner elements, simply by combining the various elements together. With this solution a special backrest cushion will be supplied, without any extra charge. The down padding will give the sofa a more unstructured and worn look, the shapes of the cushions will therefore become softer.

Elementi
Elements

AMACP110

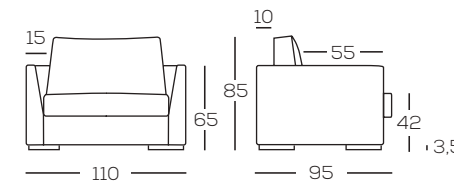

AMACD190

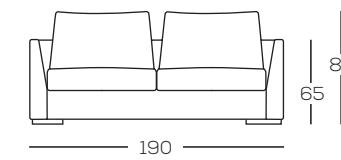

AMACD210

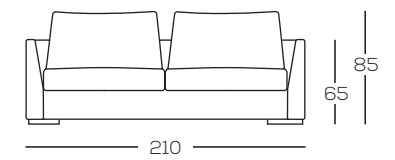

AMACD230

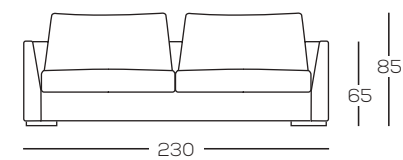

AMACD250

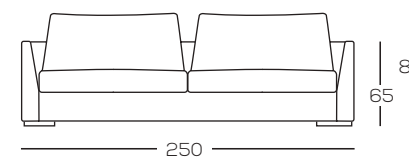

AMACD270

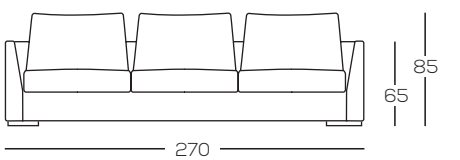

AMACC80

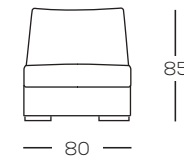

AMACC90

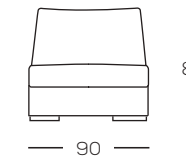

AMACC100

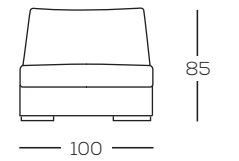

AMACC160

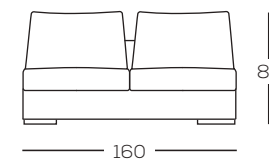

AMACC180

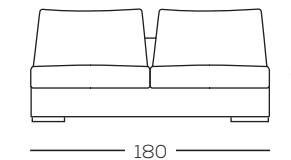

AMACC200

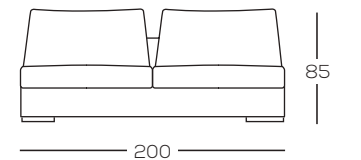

AMACC220

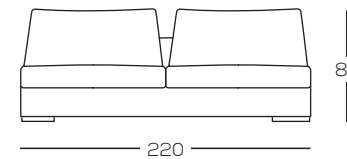

AMACC240

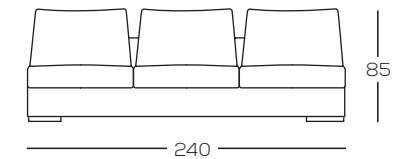

AMACA95

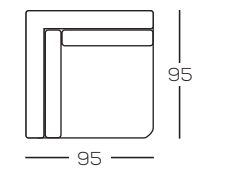

AMACR200 Dx/Sx

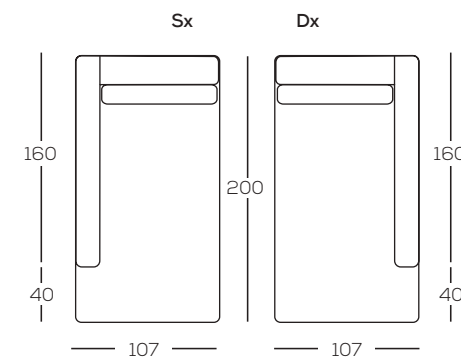

AMACBR

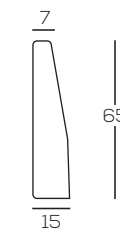

AMACPF80

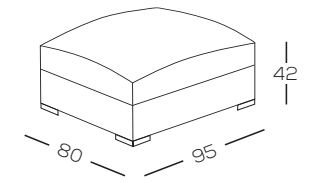

AMACPF95

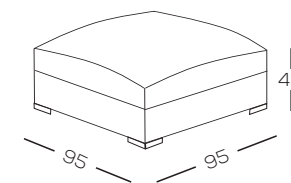

AMACPF105

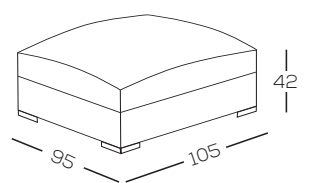

Elementi
Elements

AMACPF115

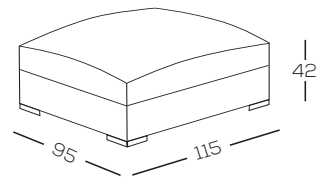

AMACPR50

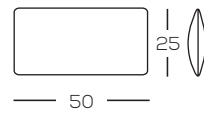

Albert

Gruppo Fox Design

Caratteristiche Features



- Rivestimenti in tessuto completamente sfoderabili con cucitura di tipo pizzicato.
Fully removable fabric covers with pinched stitching.
- Cuscini schienale in FILPIUMA (speciale miscela sofficie e ipoallergenica composta da vera piuma e fibra siliconata cava), il tutto ricoperto in tessuto a tenuta di piuma.
Back cushions in FILPIUMA (special soft and hypoallergenic mixture composed of real feather and hollow silicone fiber), all covered in feather-tight fabric.
- Struttura in legno e derivati con molleggio a cinghie elastiche ed imbottitura in poliuretano espanso, il tutto rivestito in vellutino.
Structure in wood and derivatives with springing with elastic belts and padding in polyurethane foam, all covered in velvet.
- Cuscini seduta in poliuretano espanso a quote differenziate (D40+D30) accoppiato ad un trapuntino in vera piuma, il tutto ricoperto in tessuto a tenuta di piuma.
Seat cushions in differentiated-density polyurethane foam (D40 + D30) combined with a quilt in real feather, all covered in feather-tight fabric.
- Piedi a vista in legno disponibili nella finitura wengé, noce e ciliegio.
Exposed wooden feet available in the finish wenge, walnut and cherry.

Variazioni Variations



A richiesta e con una maggiorazione, viene eseguita solo per le pelli una particolare cucitura con finitura "taglio a vivo".
Si prega di specificare le finiture al momento dell'ordine.
*Upon request and with a price increase, it is carried out only for leathers a particular stitching with "raw cut" finish.
Please specify the finishes when ordering.*



PIEDE IN TUBOLARE METALLICO CROMATO O BRONZATO
CHROMED OR BRONZED METAL TUBING FOOT

Piedi a vista in legno disponibili nella finitura wengé, noce e ciliegio.
A richiesta sono disponibili piedi in tubolare metallico cromato o bronzato con maggiorazione per il set di n.4 piedi.
Si prega di specificare le finiture al momento dell'ordine.

*Exposed wooden feet available in the finish wenge, walnut and cherry.
Upon request, feet are available in chromed or bronzed metal tubing with an extra cost for a set of n.4 feet.
Please specify the finishes when ordering.*



PIEDE LEGNO FINITURA WENGÉ, NOCE O CILIEGIO
WOOD FOOT, WENGE, WALNUT OR CHERRY FINISH

Elementi Elements

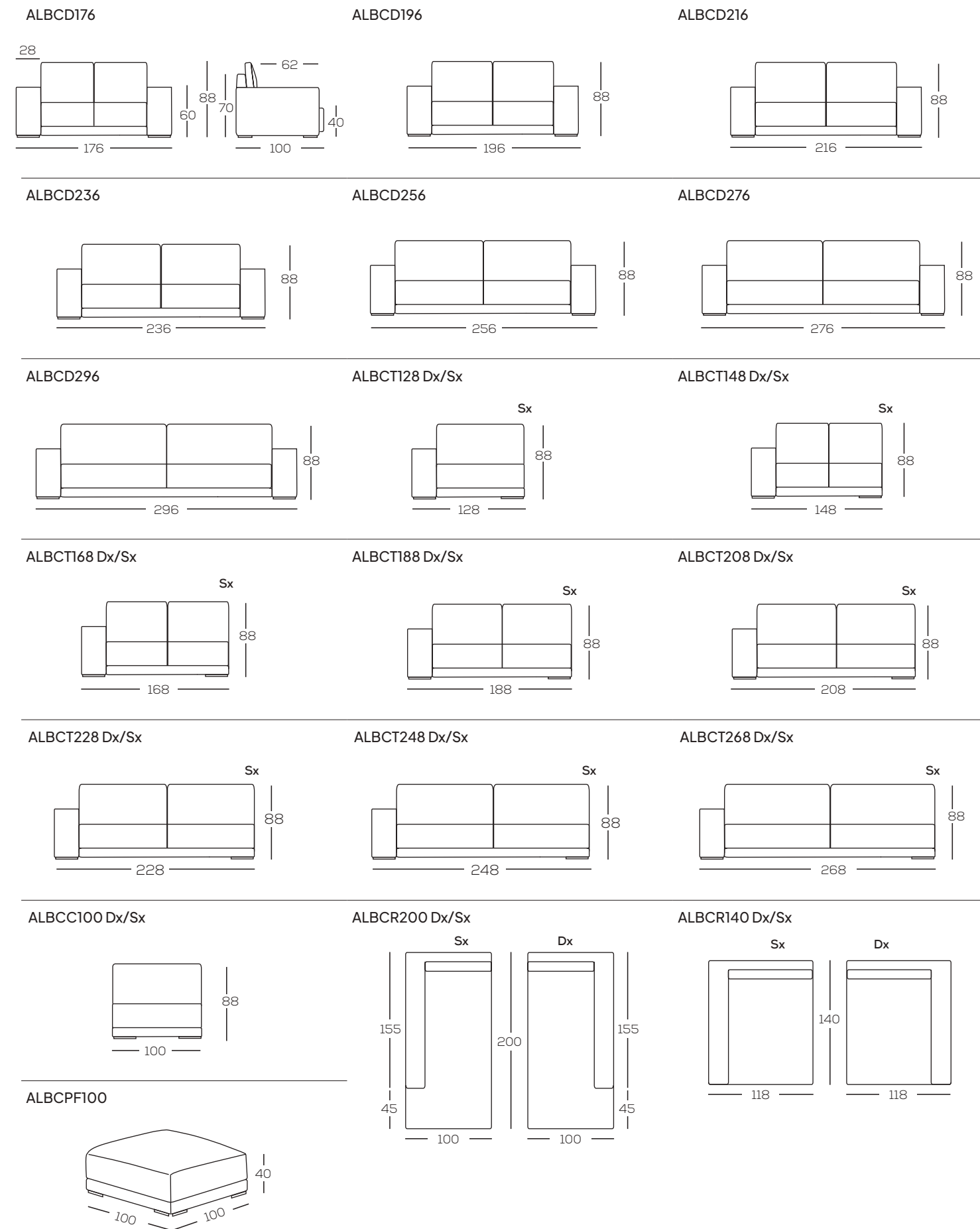

Alpha

Gruppo Fox Design

Caratteristiche Features



- Rivestimenti in tessuto completamente sfoderabili.
Fully removable fabric covers.
- Cuscini schienale in Filpiuma (speciale miscela soffice ed ipoallergenica composta da vera piuma e fibra siliconata cava), il tutto ricoperto in tessuto a tenuta di piuma.
Back cushions in Filpiuma (special soft and hypoallergenic mixture composed of real feather and hollow silicone fiber), all covered in feather-tight fabric.
- Struttura in legno e derivati con molleggio a cinghie elastiche ed imbottitura in poliuretano espanso, il tutto rivestito in vellutino.
Structure in wood and derivatives with springing with elastic belts and padding in polyurethane foam, all covered in velvet.
- Cuscini seduta in poliuretano espanso a quote differenziate accoppiato ad un trapuntino in vera piuma, il tutto ricoperto in tessuto a tenuta di piuma.
Seat cushions in differentiated-density polyurethane foam combined with a quilt in real feather, all covered in feather-tight fabric.
- Piedi a vista in alluminio disponibili nella finitura lucida o bronzata h. cm 12.
Exposed feet in aluminum available in polished or bronze finish h. 12 cm.

Variazioni Variations



PIEDE SINGOLO IN ALLUMINIO CON
FINITURA LUCIDA O BRONZATA
SINGLE FOOT IN ALUMINIUM WITH
POLISHED OR BRONZE FINISH

Piedi a vista in alluminio disponibili nella finitura lucida o bronzata h. cm 12.
Si prega di specificare le finiture al momento dell'ordine.
*Exposed feet in aluminum available in polished or bronze finish h. 12 cm.
Please specify finishings upon order.*

Le composizioni angolari si ottengono accostando semplicemente tra loro i vari elementi.
Le imbottiture in piuma conferiranno al divano un aspetto più destrutturato e vissuto, le forme dei cuscini diverranno quindi più morbide.

*The angular compositions are obtained by simply combining the various elements together.
The feather padding will give the sofa a more unstructured and worn look, the shapes of the cushions will therefore become softer.*

Elementi Elements

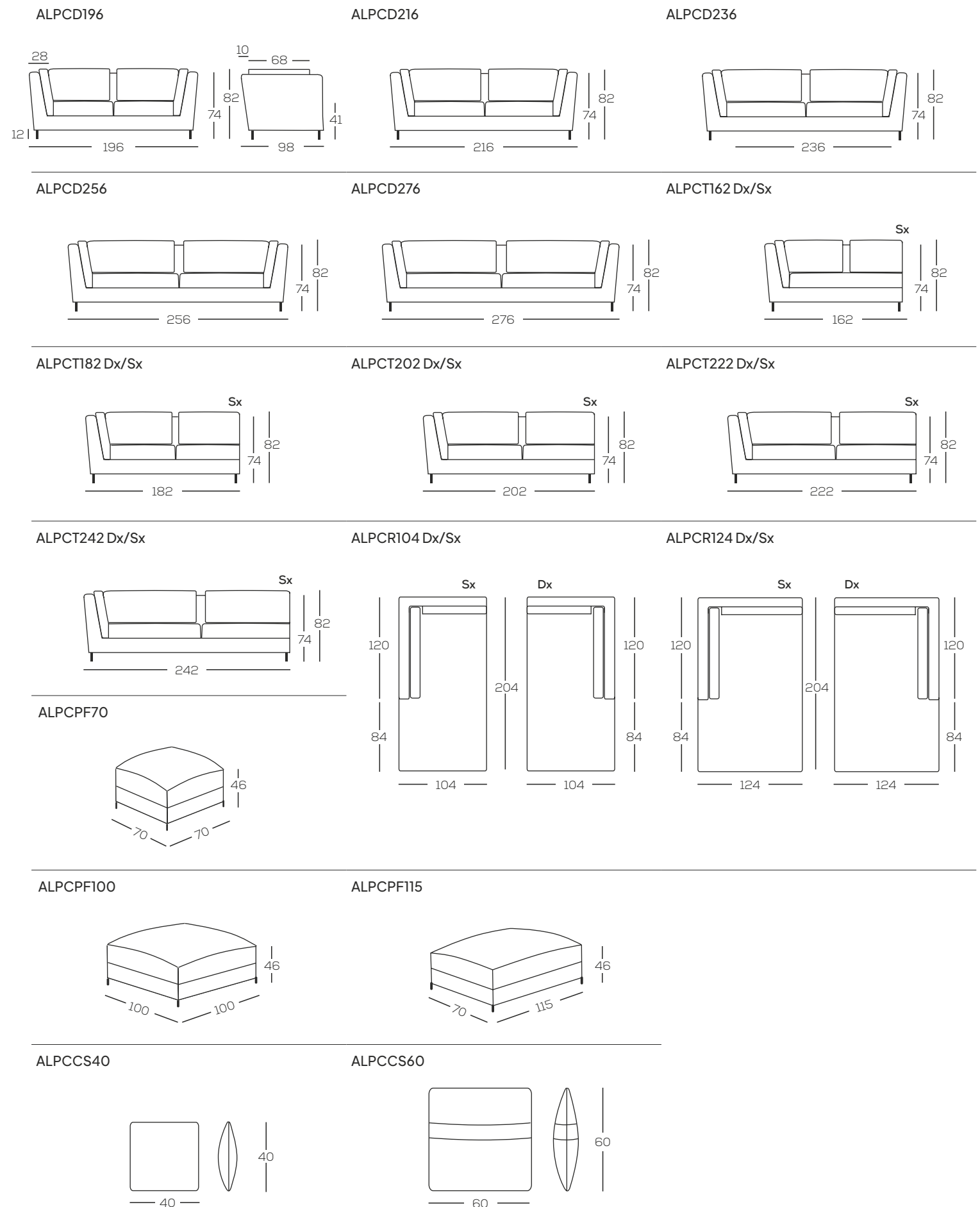

Infinity Soft

Gruppo Fox Design

Caratteristiche

Features



- Rivestimenti in tessuto completamente sfoderabili.
Fully removable fabric covers.
- Cuscini schienale in FILPIUMA (speciale miscela soffice e ipoallergenica di vera piuma e fibra poliestere siliconata cava), ricoperti in tessuto di puro cotone a tenuta di piuma.
Back cushions in FILPIUMA (special soft and hypoallergenic mixture of real feather and hollow siliconised polyester fiber), covered in feather-tight pure cotton fabric.
- Struttura in legno e derivati con molleggio a cinghie elastiche ed imbottitura in poliuretano espanso, il tutto rivestito in vellutino bianco.
Structure in wood and derivatives with springing with elastic belts and padding in polyurethane foam, all covered in white velvet.
- Cuscini seduta in piuma, marchio ORO ASSOPIUMA, con inserto in poliuretano espanso, ricoperti in tessuto di puro cotone a tenuta di piuma.
Seat cushions in feather, branded ORO ASSOPIUMA, with insert in polyurethane foam, covered in pure feather-tight cotton fabric.
- Piedi non a vista in legno, cm 18x18, disponibili nella finitura wengé, noce, ciliegio e faggio naturale.
Feet not visible in wood, 18x18 cm, available in wengé, walnut, cherry and natural beech finish

Variazioni

Variations

A richiesta e senza maggiorazioni, cuscini seduta realizzati esclusivamente con poliuretani espansi indeformabili. Si prega di specificare le finiture al momento dell'ordine.

Upon request and without surcharges, seat cushions made exclusively with non-deformable polyurethane foam. Please specify the finishes upon order.

L'elemento angolare è indispensabile per raccordare tra loro due elementi terminali. Per questo modello è prevista la possibilità di apportare modifiche dimensionali e/o sartoriali. Richiedere preventivi ai nostri uffici commerciali.

Le imbottiture in piuma conferiranno al divano un aspetto più destrutturato e vissuto, le forme dei cuscini diverranno quindi più morbide.

The angular element is indispensable to connect together two terminal elements. For this model, it is possible to make dimensional and / or tailoring changes.

Please request quotes from our sales offices.

The feather padding will give the sofa a more unstructured and worn look, the shapes of the cushions will therefore become softer.

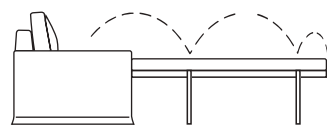

A richiesta Kit Letto: comprende una rete a tre pieghe elettrosaldada e un materasso indeformabile in poliuretano ad alta densità spessore cm 7.

Upon request Bed Kit: includes a three-fold welded bed base and a non-deformable high-density polyurethane mattress 7 cm thick.

INGOMBRO CON RETE APERTA 240 CM
OPEN NET FULL LENGTH 240 CM

Elementi

Elements

INFCE105S

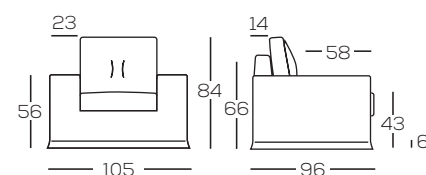

INFCD165S

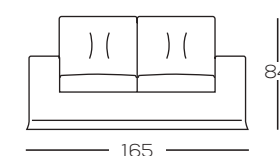

INFCD185S

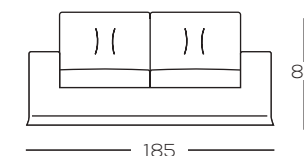

INFCD205S

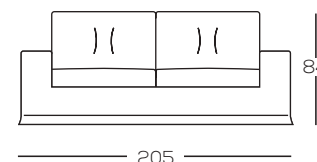

INFCD225S

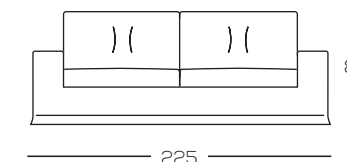

INFCD245S

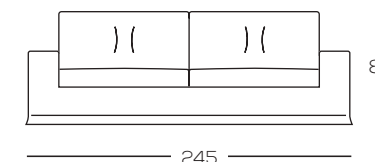

INFCD265S

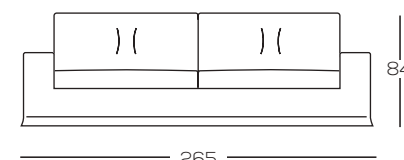

INFCD285S



INFCA103S

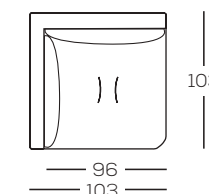

INFCT93S Dx/Sx

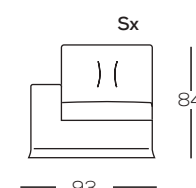

INFCT142/1S Dx/Sx

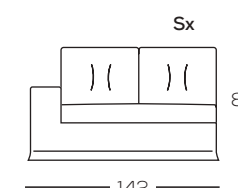

INFCT142/2S Dx/Sx

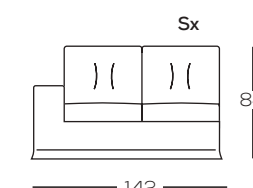

INFCT162/1S Dx/Sx

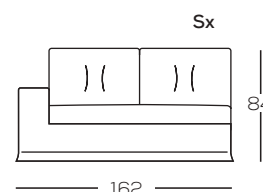

INFCT162/2S Dx/Sx

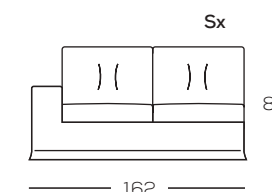

INFCT182S Dx/Sx

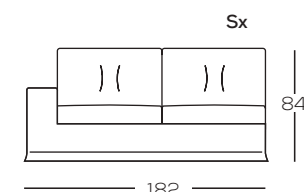

INFCT202S Dx/Sx

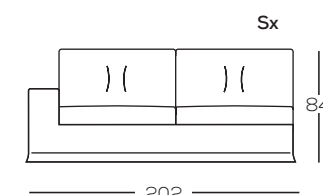

INFCT222S Dx/Sx

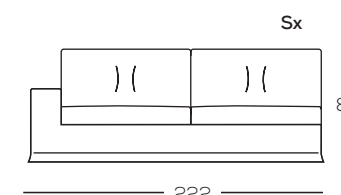

INFCT242S Dx/Sx

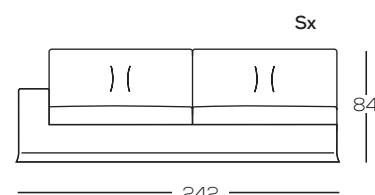

INFCT262S Dx/Sx

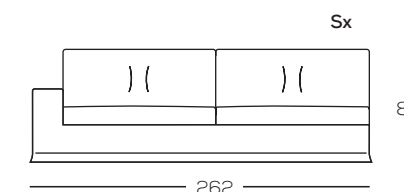

INFCEPC120S Dx/Sx

* ALTEZZA COME BRACCIOLO / ARMREST HEIGHT

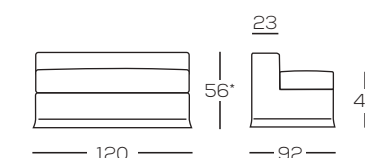

Elementi
Elements

INFCR145S Dx/Sx

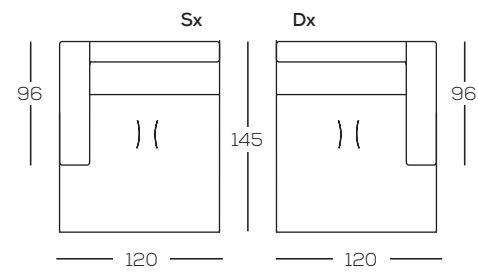

INFCR160S Dx/Sx

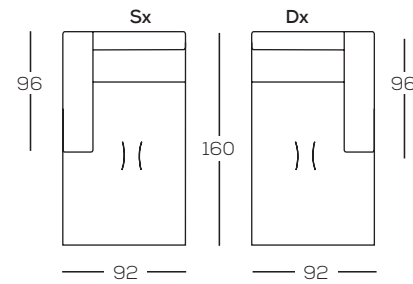

INFCPF70S

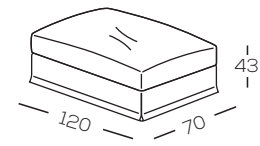

INFCPF120S

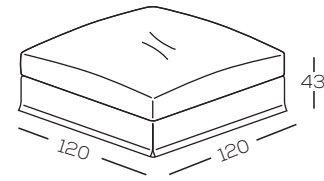

Accessori
Accessories

POGC56

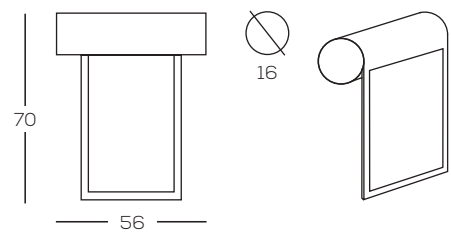

Metropolitan

Gruppo Fox Design

Caratteristiche Features



- Rivestimenti in tessuto completamente sfoderabili. Profili in cannetè, in tinta o in contrasto.
Fully removable fabric covers. Profiles in cannetè, matching or contrasting.
- Cuscini schienale in filpiuma (speciale miscela soffice ed ipoallergenica composta da vera piuma e fibra siliconata cava), il tutto ricoperto di tessuto in puro cotone a tenuta di piuma.
Back cushions in FILPIUMA (special soft and hypoallergenic mixture composed of real feather and hollow silicone fiber), all covered in feather-tight pure cotton fabric.
- Struttura in legno e derivati leggeri con molleggio a cinghie elastiche ed imbottitura in poliuretano espanso, il tutto rivestito in vellutino bianco.
Structure in wood and light derivatives with springing with elastic belts and padding in polyurethane foam, all covered in white velvet.
- Cuscini seduta in poliuretano espanso a quote differenziate con accoppiato un trapuntino in vera piuma, ricoperti di tessuto in puro cotone a tenuta di piuma.
Seat cushions in differentiated-density polyurethane foam with a real feather quilt combined, covered with feather-tight pure cotton fabric.
- Piedi non a vista h. cm 3,5 in faggio tinta wengè.
Feet not visible h. 3.5 cm in wengè-colored beech.

Variazioni Variations



PIEDI NON A VISTA IN FAGGIO
NON VISIBLE BEECH FEET



PIEDI A VISTA IN FUSIONE DI ALLUMINIO
VIEWABLE FEET IN CAST ALUMINUM

A richiesta sono disponibili piedi a vista h. cm 3,5 in fusione di alluminio nella finitura lucida o bronzata con maggiorazione.
Si prega di specificare le finiture al momento dell'ordine.

*Upon request 3.5 cm h. Feet in cast aluminum are available in glossy or bronze finish with an extra cost.
Please specify finishings upon order.*

Profili sempre in cannetè, in tinta o in contrasto.
Si prega di specificare le finiture al momento dell'ordine.
Le imbottiture in piuma conferiranno al divano un aspetto più destrutturato e vissuto, le forme dei cuscini diverranno quindi più morbide.

Profiles always in cannetè stitching, matching or contrasting.

Please specify the finishes upon ordering.

The feather padding will give the sofa a more unstructured and worn look, the shapes of the cushions will therefore become softer.

Elementi Elements

METCP130

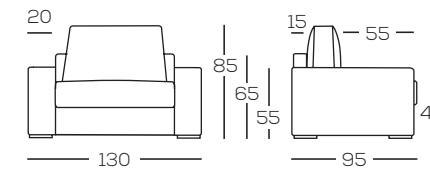

METCD200

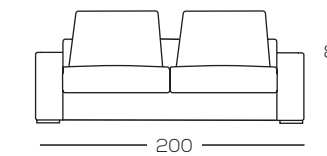

METCD220

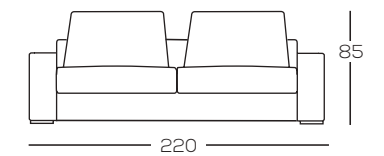

METCD240

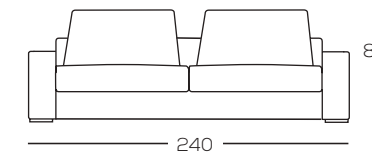

METCD260

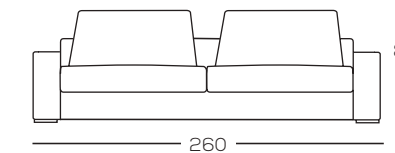

METCD280

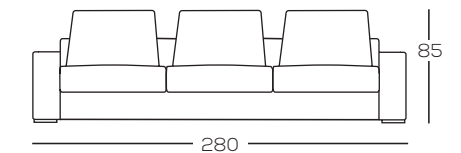

METCC90

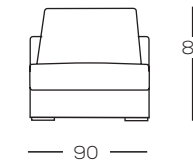

METCC100

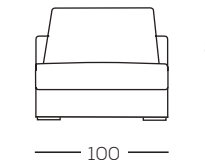

METCC160

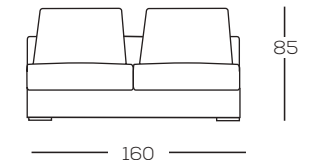

METCC180

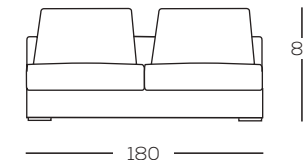

METCC200

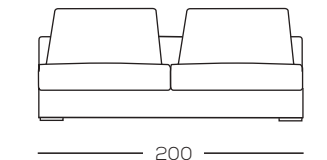

METCC220

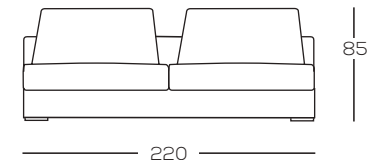

METCC240

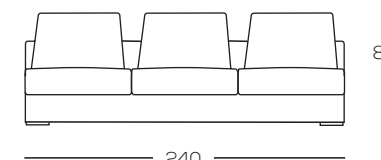

METCA95

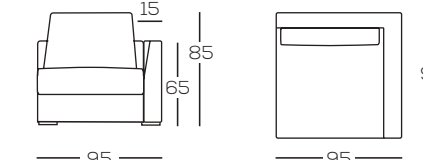

METCBR

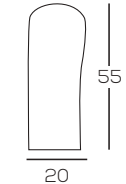

METCPR50

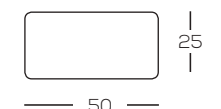

METCPF95

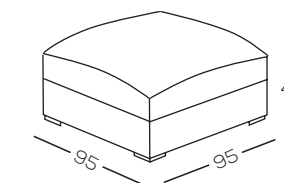

METCPF105

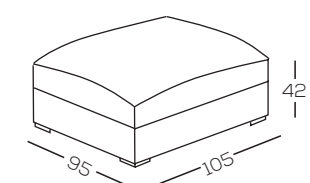

METCPF115

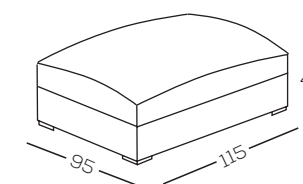

Asso

Gruppo Fox Design

Caratteristiche Features

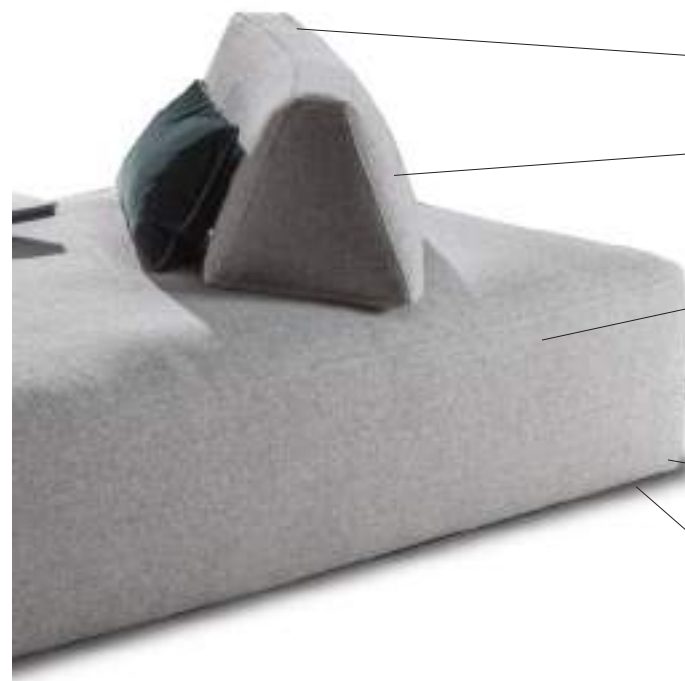

- Rivestimenti in tessuto completamente sfoderabili.
Fully removable fabric covers.
- Schienale curvo in poliuretano espanso con base in legno inserita per aiutarne la staticità.
Curved backrest in polyurethane foam with inserted wooden base to help its static.
- Sedute monoscocca in poliuretano espanso a quote differenziate accoppiato ad un trapuntino in piuma, il tutto ricoperto di tessuto in puro cotone a tenuta di piuma.
Monocoque seats in differentiated-density polyurethane foam coupled with a feather quilt, all covered in feather-tight pure cotton fabric.
- Struttura in legno e derivati leggeri con imbottitura in poliuretano espanso, il tutto rivestito in vellutino.
Structure in wood and light derivatives with padding in polyurethane foam, all covered in velvet.
- Piedi a scomparsa in ABS nero con inserto antiscivolo.
Invisible feet in black ABS with non-slip insert.

Variazioni Variations

Isola monoscocca accostabile a tutti i terminali dei divani con altezza di seduta a 42 cm.

Monocoque island that can be joined to all the ends of the sofas with a seat height of 42 cm.

Elementi Elements

ASSCB204

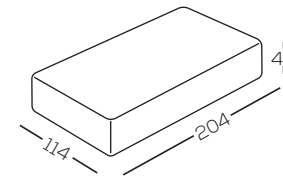

ASSCB224

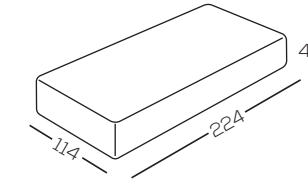

ASSCB244

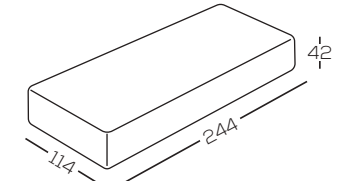

ASSCCS75

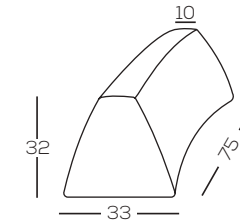

Arrigo

Gruppo Fox Design

Caratteristiche Features



- Rivestimenti in tessuto completamente sfoderabili.
Fully removable fabric covers.
- Cuscini seduta e schienale in vera piuma, ricoperti in tessuto di puro cotone a tenuta di piuma.
Seat and back cushions in real feather, covered in pure feather-tight cotton fabric.
- Struttura in legno e derivati con molleggio a cinghie elastiche ed imbottitura in poliuretano espanso, il tutto rivestito in vellutino bianco.
Structure in wood and derivatives with springing with elastic belts and padding in polyurethane foam, all covered in white velvet.
- Piedi non a vista in ABS nero.
Feet not visible in black ABS.

Variazioni Variations

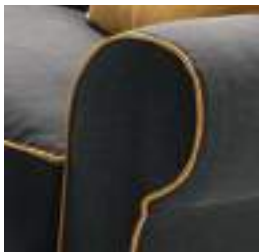

A richiesta, solo per tessuti, e con una maggiorazione, viene eseguito il bordino in contrasto in cannetè. Si prega di indicare il codice tessuto per referenza colore.

Upon request, only for fabrics and with an extra cost, the contrasting border in cannetè is available. Please indicate the fabric code for color reference.

Per questo modello è prevista la possibilità di apportare modifiche sartoriali e/o dimensionali.

Richiedere preventivi ai nostri uffici commerciali.

Le imbottiture in piuma conferiranno al divano un aspetto più destrutturato e vissuto, le forme dei cuscini diverranno quindi più morbide.

For this model it is possible to make sartorial and / or dimensional changes.

Please request quotes from our sales offices.

The down padding will give the sofa a more unstructured and worn look, the shapes of the cushions will therefore become softer.

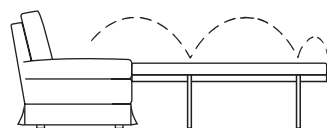

INGOMBRO CON RETE APERTA 235 CM
OPEN NET FULL LENGTH 235 CM

A richiesta Kit Letto: comprende una rete a tre pieghe elettrosaldada e un materasso indeformabile in poliuretano ad alta densità spessore cm 7.

Upon request Bed Kit: includes a three-fold welded bed base and a non-deformable high-density polyurethane mattress 7 cm thick.

Elementi Elements

ARRCP93

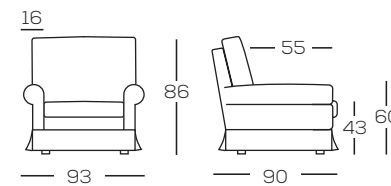

ARRCD150

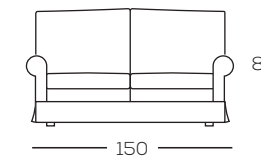

ARRCD170

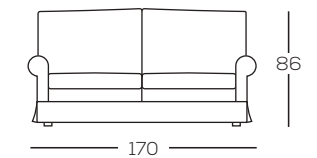

ARRCD190

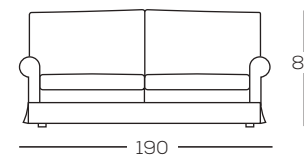

ARRCD2102

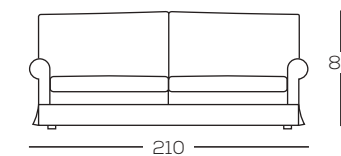

ARRCD2103

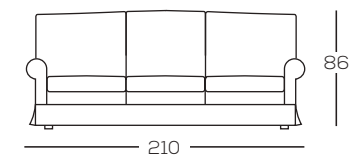

ARRCD240

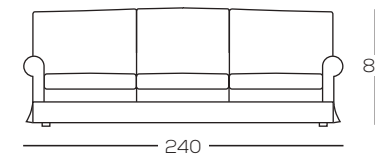

ARRCPF60

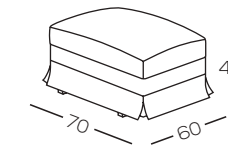

Simon

Gruppo Fox Design

Caratteristiche
Features



- Rivestimenti in tessuto completamente sfoderabili.
Fully removable fabric covers.
- Cuscini schienale in vera piuma canalizzata, garantita Assopiuma, ricoperti in tessuto in puro cotone a tenuta di piuma.
Back cushions in real canalized down, guaranteed Assopiuma, covered in pure downproof cotton fabric.
- Struttura in legno massello e derivati leggeri, con imbottitura in poliuretano espanso, il tutto rivestito in vellutino.
Structure in solid wood and light derivatives, with polyurethane foam padding, all covered in velveteen.
- Cuscini seduta in poliuretano espanso a densità differenziate con strato superficiale in memory foam, rivestiti in vellutino.
Seat cushions in polyurethane foam with different densities with a surface layer of memory foam, covered in velveteen.
- Piedi in fusione di alluminio disponibili nella finitura bronzata.
Feet in cast aluminum available in bronzed finish.

Variazioni
Variations



PIEDI IN FUSIONE DI ALLUMINIO
FEET IN CAST ALUMINUM



TELAIO IN FUSIONE DI ALLUMINIO CON FINITURA BRONZATA
CAST ALUMINUM FRAME IN BRONZED FINISH

A richiesta è disponibile un telaio in fusione di alluminio con finitura bronzata, con un supplemento
Si prega di specificare le finiture al momento dell'ordine.

Upon request a cast aluminum frame in bronzed finish is available at an additional cost. Please specify finishings upon order.

Elementi
Elements

SIMCP100

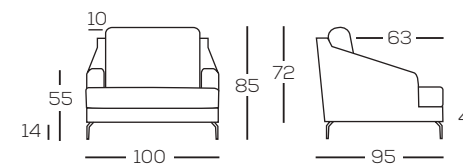

SIMCD180

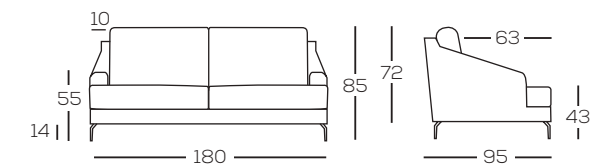

SIMCD200

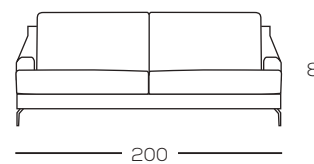

SIMCD220

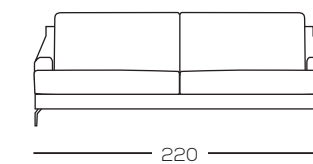

SIMCD240

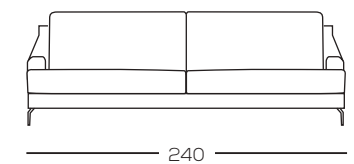

SIMCD260

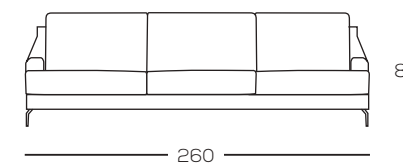

SIMCT170 Dx/Sx

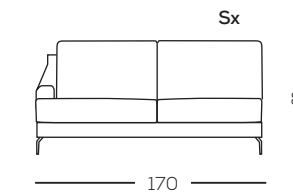

SIMCT190 Dx/Sx

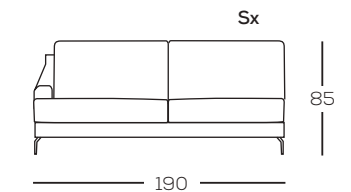

SIMCT210 Dx/Sx

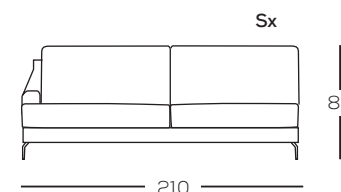

SIMCT230 Dx/Sx

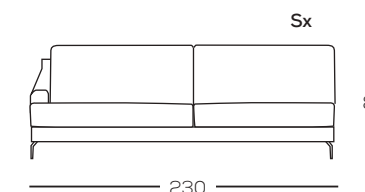

SIMCT250 Dx/Sx

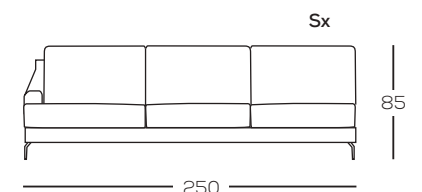

SIMCR170 Dx/Sx

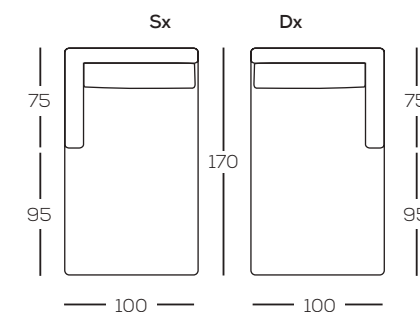

SIMCA95 Dx/Sx

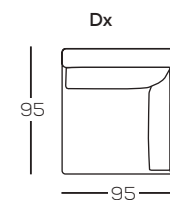

SIMCPF95

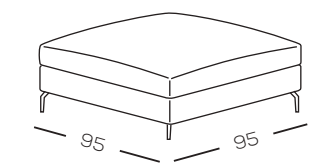

SIMCTA220 Dx/Sx

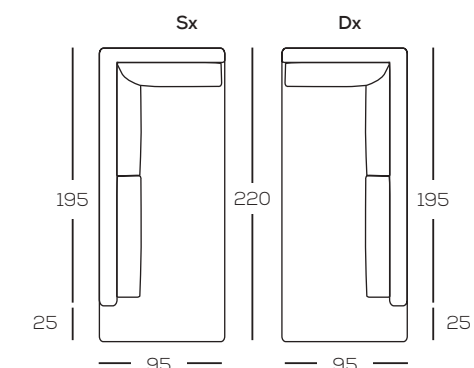

Brad

Gruppo Fox Design

Caratteristiche Features



- Rivestimenti in tessuto completamente sfoderabili.
Fully removable fabric covers.
- Cuscini schienale in FILPIUMA (speciale miscela soffice e ipoallergenica di vera piuma e fibra di poliestere siliconata cava), ricoperti in tessuto di puro cotone a tenuta di piuma.
Back cushions in FILPIUMA (special soft and hypoallergenic mixture of real feather and hollow siliconised polyester fiber), covered in feather-tight pure cotton fabric.
- Struttura in legno e derivati leggeri con molleggio a cinghie elastiche ed imbottitura in poliuretano espanso, il tutto rivestito in vellutino bianco.
Structure in wood and light derivatives with springing with elastic belts and padding in polyurethane foam, all covered in white velvet.
- Cuscini seduta in poliuretano espanso a quote differenziate con accoppiato un trapuntino in vera piuma, ricoperti di tessuto in puro cotone a tenuta di piuma.
Seat cushions in differentiated-density polyurethane foam with a real feather quilt, covered in feather-tight pure cotton fabric.
- Piedi non a vista in faggio tinta wengè.
Feet not visible in wengè-colored beech.

Variazioni Variations

Le composizioni angolari si ottengono accostando semplicemente tra loro i vari elementi.
Con queste soluzioni verrà fornito anche un apposito cuscino schienale di raccordo, senza alcun sovrapprezzo.
Per questo modello è prevista la possibilità di apportare modifiche dimensionali.
Richiedere preventivi ai nostri uffici commerciali.
Le imbottiture in piuma conferiranno al divano un aspetto più destrutturato e vissuto, le forme dei cuscini diverranno quindi più morbide.

*Angular compositions are obtained by simply combining the various elements together.
These solutions will also be provided with a special connecting back cushion, without any extra charge.
For this model it is possible to make dimensional changes.*

*Please request quotes from our sales offices.
The feather padding will give the sofa a more unstructured and worn look, the shapes of the cushions will therefore become softer.*



A richiesta e con maggiorazione viene eseguita (solo per tessuti) una particolare cucitura rovesciata, con sorfilo a vista, sia in tinta che in contrasto.
Si prega di specificare le finiture al momento dell'ordine.

*Upon request and with a price increase a particular upside-down stitching is performed (only for fabrics), with visible overcasting, both in color and in contrast.
Please specify finishings upon order.*

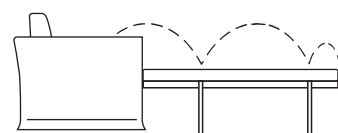

A richiesta Kit Letto: comprende una rete a tre pieghe elettrosaldata e un materasso indeformabile in poliuretano ad alta densità spessore cm 7.

Upon request Bed Kit: includes a three-fold welded bed base and a non-deformable high-density polyurethane mattress 7 cm thick.

INGOMBRO CON RETE APERTA 245 CM
OPEN NET FULL LENGTH 245 CM

Elementi Elements

BRACD170

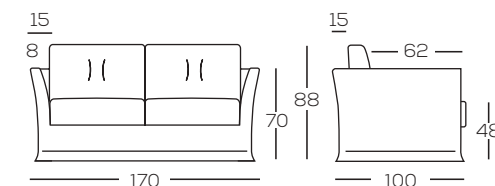

BRACD190

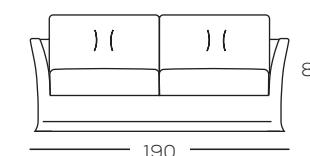

BRACD210

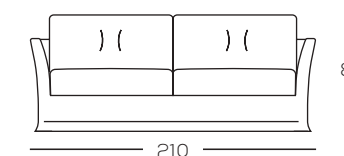

BRACD230

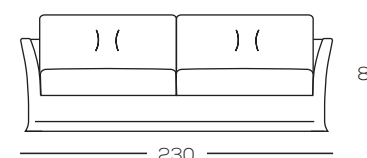

BRACD250

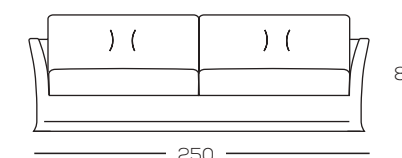

BRAC155 Dx/Sx

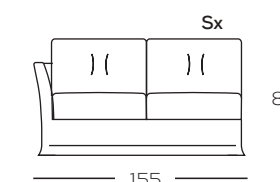

BRAC175 Dx/Sx

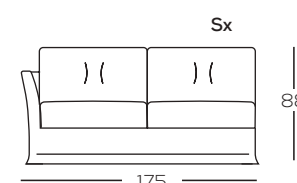

BRAC195 Dx/Sx

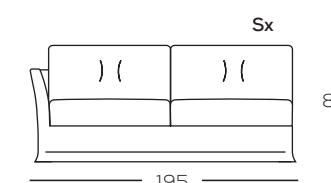

BRAC215 Dx/Sx

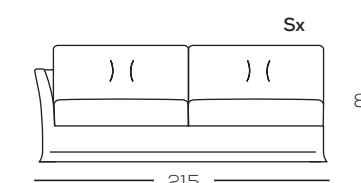

BRAC235 Dx/Sx

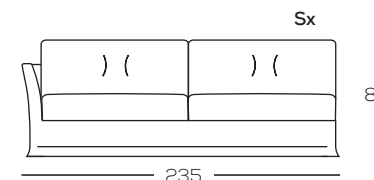

BRACR160 Dx/Sx

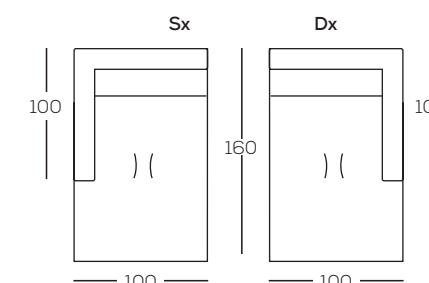

BRACR210 Dx/Sx

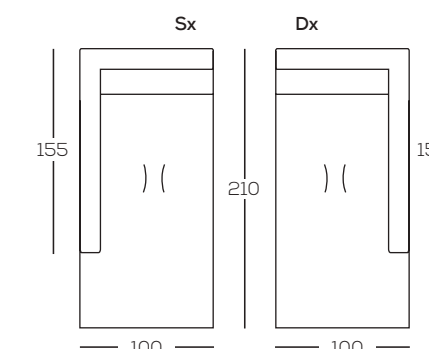

BRACPF60

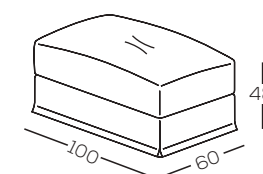

BRACPF100

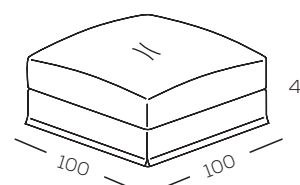

Artemide

GruppoFox Design

Caratteristiche Features



- Rivestimenti non sfoderabili.
Non removable covers.
- Struttura della scocca in legno massello e composito curvato, imbottitura in poliuretano espanso a quote differenziate, sedile in dacron.
Body structure in solid wood and curved composite, padding in differentiated-density polyurethane foam, seat in dacron.
- Imbottitura ignifuga in poliuretano espanso CM 40 P.
Fireproof padding in expanded polyurethane CM 40 P.
- Piedi in metallo verniciato nero.
Feet in black varnished metal.

Elementi Elements

ARTCP78

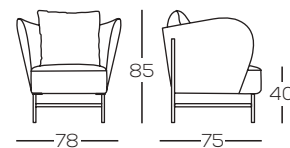

Mirto

GruppoFox Design

Caratteristiche Features



- Rivestimenti non sfoderabili.
Non removable covers.
- Struttura della scocca in legno massello e composito curvato.
Body structure in solid wood and curved composite.
- Sedile in poliuretano e dacron
Seat in polyurethane and dacron
- Imbottitura ignifuga in Poliuretano espanso a quote differenziate D 40 RC e D 25 CM.
Fireproof padding in polyurethane foam of different densities D 40 RC and D 25 CM.
- Piedino regolabile in ABS.
Adjustable ABS foot.

Variazioni Variations

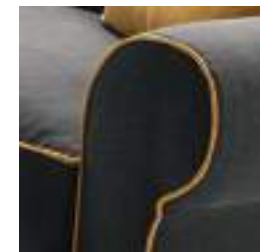

Profili schienale in tinta o in contrasto, si prega di specificare le finiture al momento dell'ordine. Si prega di indicare il codice tessuto per referenza colore.

Matching or contrasting backrest profiles, please specify the finishes when ordering. Please indicate the fabric code for color reference.

Elementi Elements

MIRCP56

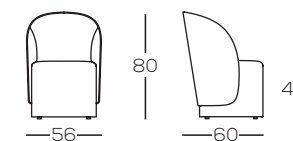

Daphne

GruppoFox Design

Caratteristiche Features



- Rivestimenti non sfoderabili.
Non removable covers.
- Struttura della scocca interamente stampata in poliuretano schiumato a freddo.
Body structure entirely molded in cold-foamed polyurethane.
- Imbottitura ignifuga in poliuretano espanso "CYFLEXIM-A1" densità media 60 kg/mc.
Fireproof padding in "CYFLEXIM-A1" expanded polyurethane, average density 60 kg/m³.
- Basamento in legno di faggio verniciato nelle finiture frassino naturale, rovere naturale, nero, noce canaletto e noce scuro.
Base in beech wood painted in natural ash, natural oak, black, canaletto walnut and dark walnut finishes.

Variazioni Variations

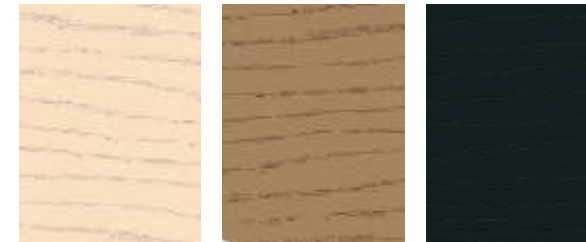

FRASSINO NATURALE ROVERE NATURALE NERO
NATURAL ASH NATURAL OAK BLACK



NOCE CANALETTO NOCE SCURO
CANALETTO WALNUT DARK WALNUT

Basamento legno di faggio verniciato nelle finiture frassino naturale, rovere naturale, nero, noce canaletto e noce scuro.
Si prega di specificare le finiture al momento dell'ordine.

*Base in beech wood painted in natural ash, natural oak, black, canaletto walnut and dark walnut finishes.
Please specify the finishes when ordering.*

Elementi Elements

DAPCP86

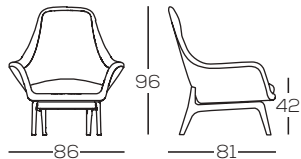

Diana

GruppoFox Design

Caratteristiche Features



- Rivestimenti non sfoderabili.
Non removable covers.
- Struttura portante in poliuretano rigido con imbottitura in poliuretano espanso ultra soft.
Supporting structure in rigid polyurethane with ultra soft expanded polyurethane padding.
- Imbottitura ignifuga in poliuretano espanso "ILPOFLEX 11M", massa volumica 60 kg/m³.
Fireproof padding in "ILPOFLEX 11M" expanded polyurethane, density 60 kg/m³.
- Basamento girevole in metallo cromato o verniciato nero. Oppure in legno di faggio verniciato nelle finiture frassino naturale, rovere naturale, nero, noce canaletto e noce scuro.
Revolving base in chromed or black painted metal. Or in beech wood painted in natural ash, natural oak, black, canaletto walnut and dark walnut finishes.

Note Notes



- **POUFF**
• Struttura della scocca in metallo, interamente stampata in poliuretano schiumato a freddo.
Metal body structure, entirely molded in cold-foamed polyurethane.
- Imbottitura in poliuretano ignifugo indeformabile stampato a freddo, densità media 60 kg/mc
Padding in cold-moulded, non-deformable fireproof polyurethane, average density 60 kg/m³
- Basi disponibili come poltroncina Diana. Si prega di specificare le finiture al momento dell'ordine.
Bases available as Diana armchair. Please specify the finishes when ordering.

Elementi Elements

DIACP82

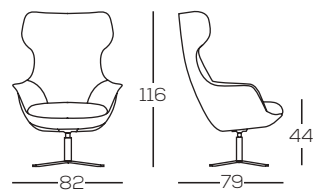

DIACPF55



Variazioni Variations

VERSIONE STANDARD
STANDARD VERSIONVERSIONE SOFT
SOFT VERSION

A richiesta (su poltroncina), è possibile ordinare la poltroncina versione soft con un aspetto più soffice e destrutturato.
Si prega di specificare le finiture al momento dell'ordine.

*Upon request (on the armchair), it is possible to order the soft version armchair with a softer and more unstructured appearance.
Please specify the finishes when ordering.*

R13
METALLO CROMATO O
VERNICIATO NEROCHROMED OR BLACK
VARNISHED METALR7
METALLO CROMATO O
VERNICIATO NEROCHROMED OR BLACK
VARNISHED METAL

• Basamento girevole (R13, R7) in metallo cromato o verniciato nero.
Si prega di specificare le finiture al momento dell'ordine.

• *Revolving base (R13, R7) in chromed or black painted metal.
Please specify the finishes when ordering.*

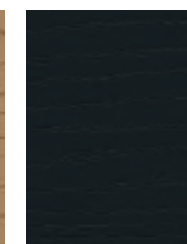
L21
LEGNO
WOODFRASSINO NATURALE
NATURAL ASHROVERE NATURALE
NATURAL OAKNERO
BLACK

• Basamento girevole (L21) in legno di faggio verniciato nelle finiture frassino naturale, rovere naturale, nero, noce canaletto e noce scuro.

Si prega di specificare le finiture al momento dell'ordine.

• *Revolving base (L21) in beech wood painted in natural ash, natural oak, black, canaletto walnut and dark walnut finishes.*

Please specify the finishes when ordering.

NOCE CANALETTO
CANALETTO WALNUTNOCE SCURO
DARK WALNUT

Partenope

GruppoFox Design

Caratteristiche Features



- Rivestimenti non sfoderabili.
Non removable covers.
- Struttura della scocca in acciaio, interamente stampata in poliuretano schiumato a freddo.
Steel body structure, entirely molded in cold-foamed polyurethane.
- Imbottitura ignifuga in Poliuretano indeformabile stampato a freddo, densità media 60 kg/mc.
Fireproof padding in non-deformable cold-moulded polyurethane, average density 60 kg/m³.
- Basamento (fisso o girevole) in metallo cromato o verniciato nero. Oppure in legno di faggio verniciato nelle finiture frassino naturale, rovere naturale, nero, noce canaletto e noce scuro.
(Revolving or fixed) base in chromed or black painted metal. Or in beech wood painted in natural ash, natural oak, black, canaletto walnut and dark walnut finishes.

Elementi Elements

PARCP78

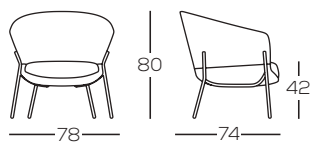

Variazioni Variations



R13
METALLO CROMATO O
VERNICIATO NERO

CHROMED OR BLACK
VARNISHED METAL



R7
METALLO CROMATO O
VERNICIATO NERO

CHROMED OR BLACK
VARNISHED METAL



P29
METALLO CROMATO O
VERNICIATO NERO

CHROMED OR BLACK
VARNISHED METAL



L21
LEGNO
WOOD



FRASSINO NATURALE
NATURAL ASH



ROVERE NATURALE
NATURAL OAK

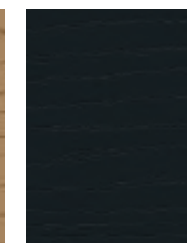

NERO
BLACK



NOCE CANALETTO
CANALETTO WALNUT



NOCE SCURO
DARK WALNUT

• Basamento girevole (R13, R7) in metallo cromato o verniciato nero. Si prega di specificare le finiture al momento dell'ordine.

• *Revolving base (R13, R7) in chromed or black painted metal. Please specify the finishes when ordering.*

• Basamento fisso (P29) in metallo cromato o verniciato nero. Si prega di specificare le finiture al momento dell'ordine.

• *Fixed base (P29) in chromed or black painted metal. Please specify the finishes when ordering.*

• Basamento girevole (L21) in legno di faggio verniciato nelle finiture frassino naturale, rovere naturale, nero, noce canaletto e noce scuro.

Si prega di specificare le finiture al momento dell'ordine.

• *Revolving base (L21) in beech wood painted in natural ash, natural oak, black, canaletto walnut and dark walnut finishes.*

Please specify the finishes when ordering.

Tecla

GruppoFox Design

Caratteristiche Features



- Rivestimenti non sfoderabili.
Non removable covers.
- Struttura della scocca in acciaio, interamente stampata in poliuretano schiumato a freddo.
Steel body structure, entirely molded in cold-foamed polyurethane.
- Imbottitura ignifuga in poliuretano indeformabile stampato a freddo, densità media 60 kg/mc.
Fireproof padding in non-deformable cold-molded polyurethane, average density 60 kg/m3.
- Gambe in legno di frassino verniciate nelle finiture frassino naturale, rovere naturale, nero, noce canaletto e noce scuro. Oppure, basamento (girevole o fisso) in metallo cromato o verniciato nero.
Legs in beech wood painted in natural ash, natural oak, black, canaletto walnut and dark walnut finishes. Or (revolving or fixed) base in chromed or black painted metal.

Elementi Elements

TECCP73

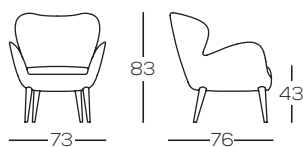

Variazioni Variations



R13
METALLO CROMATO O
VERNICIATO NERO

CHROMED OR BLACK
VARNISHED METAL



R7
METALLO CROMATO O
VERNICIATO NERO

CHROMED OR BLACK
VARNISHED METAL



S7
METALLO CROMATO O
VERNICIATO NERO

CHROMED OR BLACK
VARNISHED METAL



L31
LEGNO

WOOD



GL
LEGNO

WOOD



L21
LEGNO

WOOD

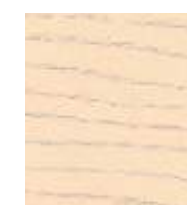

FRASSINO NATURALE
NATURAL ASH



ROVERE NATURALE
NATURAL OAK

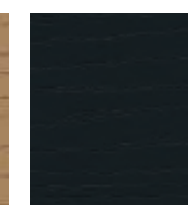

NERO
BLACK

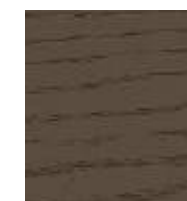

NOCE CANALETTO
CANALETTO WALNUT



NOCE SCURO
DARK WALNUT

• Basamento girevole (R13, R7) in metallo cromato o verniciato nero. Si prega di specificare le finiture al momento dell'ordine.

• *Revolving base (R13, R7) in chromed or black painted metal. Please specify the finishes when ordering.*

• Basamento fisso (S7) in metallo cromato o verniciato nero. Si prega di specificare le finiture al momento dell'ordine.

• *Fixed base (S7) in chromed or black painted metal. Please specify the finishes when ordering.*

• Basamento fisso (L31, GL) in legno di faggio verniciato nelle finiture frassino naturale, rovere naturale, nero, noce canaletto e noce scuro.

• Basamento girevole (L21) in legno di faggio verniciato nelle finiture frassino naturale, rovere naturale, nero, noce canaletto e noce scuro.

Si prega di specificare le finiture al momento dell'ordine.

• *Fixed base (L31, GL) in beech wood painted in natural ash, natural oak, black, canaletto walnut and dark walnut finishes.*

• *Revolving base (L21) in beech wood painted in natural ash, natural oak, black, canaletto walnut and dark walnut finishes.*

Please specify the finishes when ordering.

Athena

GruppoFox Design

Caratteristiche Features



- Rivestimenti non sfoderabili.
Non removable covers.
- Cuscino sedile stampato in poliuretano schiumato a freddo.
Seat cushion molded in cold foamed polyurethane.
- Struttura della scocca in acciaio, interamente stampata in poliuretano schiumato a freddo.
Steel body structure, entirely molded in cold foamed polyurethane.
- Basamento girevole in metallo cromato o verniciato nero. Oppure in legno di faggio verniciato nelle finiture frassino naturale, rovere naturale, nero, noce canaletto e noce scuro.
Revolving base in chromed or black painted metal. Or in beech wood painted in natural ash, natural oak, black, canaletto walnut and dark walnut finishes.

Variazioni Variations



R13
BASAMENTO GIREVOLE
IN METALLO
REVOLVING BASE IN METAL



L21
BASAMENTO GIREVOLE
IN LEGNO
REVOLVING BASE IN WOOD

- Basamento girevole (R13) in metallo cromato o verniciato nero.
 - Basamento girevole (L21) in legno di faggio verniciato nelle finiture frassino naturale, rovere naturale, nero, noce canaletto e noce scuro.
- Si prega di specificare le finiture al momento dell'ordine.

- *Revolving base (R13) in chromed or black painted metal.*
 - *Revolving base (L21) in beech wood painted in natural ash, natural oak, black, canaletto walnut and dark walnut finishes.*
- Please specify the finishes when ordering.

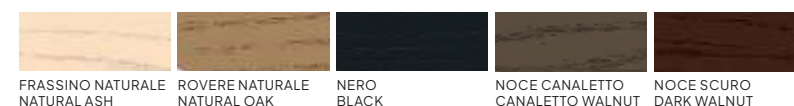

Elementi Elements

ATHCP77

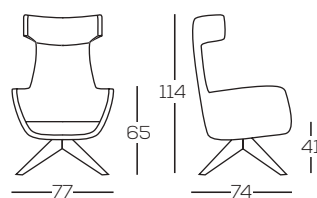

ATHCPF56

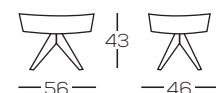

Hydra

GruppoFox Design

Caratteristiche Features



- Rivestimenti non sfoderabili.
Non removable covers.
- Struttura della scocca in acciaio, interamente stampata in poliuretano schiumato a freddo.
Steel body structure, entirely molded in cold foamed polyurethane.
- Cuscino sedile stampato in poliuretano schiumato a freddo a doppia densità.
Seat cushion molded in double density cold-foamed polyurethane.
- Basamento girevole in metallo cromato o verniciato nero. Oppure in legno di faggio verniciato nelle finiture frassino naturale, rovere naturale, nero, noce canaletto e noce scuro.
Revolving base in chromed or black painted metal. Or in beech wood painted in natural ash, natural oak, black, canaletto walnut and dark walnut finishes.

Variazioni Variations



R13
BASAMENTO GIREVOLE
IN METALLO
REVOLVING BASE IN METAL



L21
BASAMENTO GIREVOLE
IN LEGNO
REVOLVING BASE IN WOOD

- Basamento girevole (R13) in metallo cromato o verniciato nero.
 - Basamento girevole (L21) in legno di faggio verniciato nelle finiture frassino naturale, rovere naturale, nero, noce canaletto e noce scuro.
- Si prega di specificare le finiture al momento dell'ordine.

- *Revolving base (R13) in chromed or black painted metal.*
 - *Revolving base (L21) in beech wood painted in natural ash, natural oak, black, canaletto walnut and dark walnut finishes.*
- Please specify the finishes when ordering.

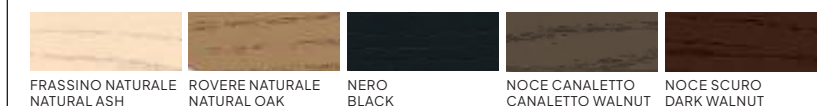

Elementi Elements

HYDCP81

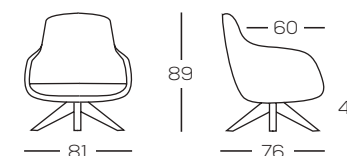

Kea

GruppoFox Design

Caratteristiche Features

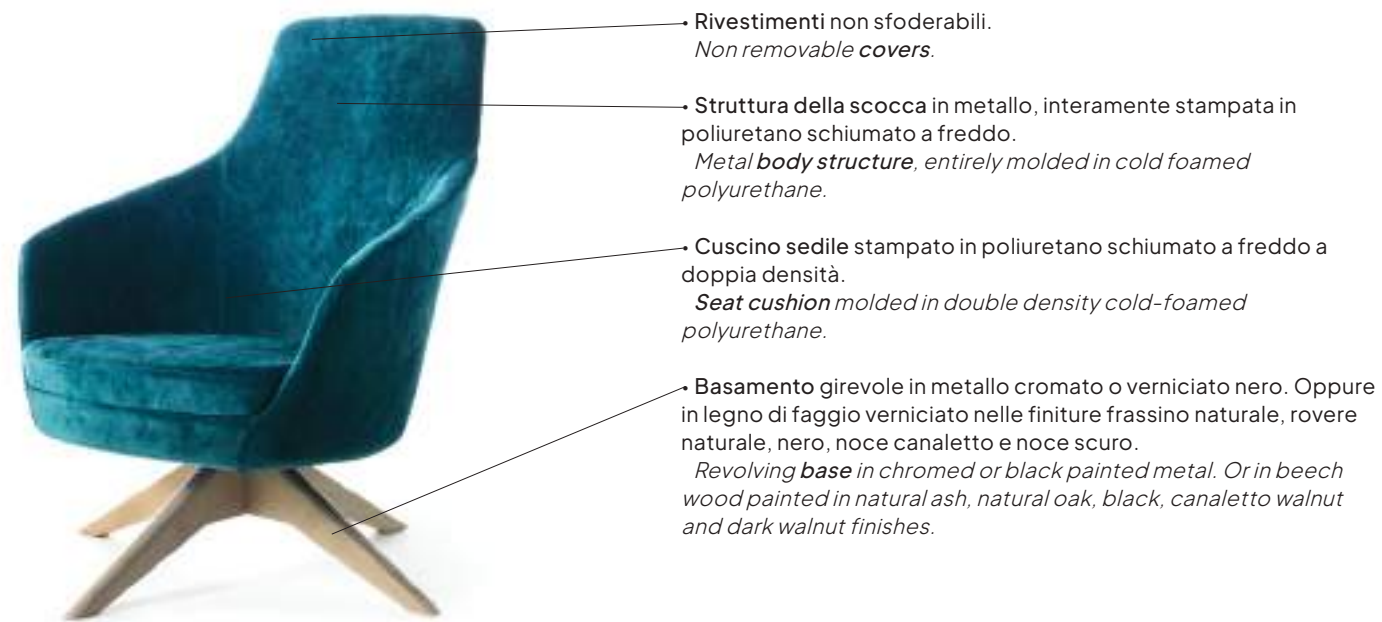

- Rivestimenti non sfoderabili.
Non removable covers.
- Struttura della scocca in metallo, interamente stampata in poliuretano schiumato a freddo.
Metal body structure, entirely molded in cold foamed polyurethane.
- Cuscino sedile stampato in poliuretano schiumato a freddo a doppia densità.
Seat cushion molded in double density cold-foamed polyurethane.
- Basamento girevole in metallo cromato o verniciato nero. Oppure in legno di faggio verniciato nelle finiture frassino naturale, rovere naturale, nero, noce canaletto e noce scuro.
Revolving base in chromed or black painted metal. Or in beech wood painted in natural ash, natural oak, black, canaletto walnut and dark walnut finishes.

Variazioni Variations



R13
BASAMENTO GIREVOLE
IN METALLO
REVOLVING BASE IN METAL



L21
BASAMENTO GIREVOLE
IN LEGNO
REVOLVING BASE IN WOOD

- Basamento girevole (R13) in metallo cromato o verniciato nero.
 - Basamento girevole (L21) in legno di faggio verniciato nelle finiture frassino naturale, rovere naturale, nero, noce canaletto e noce scuro.
- Si prega di specificare le finiture al momento dell'ordine.

- *Revolving base (R13) in chromed or black painted metal.*
 - *Revolving base (L21) in beech wood painted in natural ash, natural oak, black, canaletto walnut and dark walnut finishes.*
- Please specify the finishes when ordering.

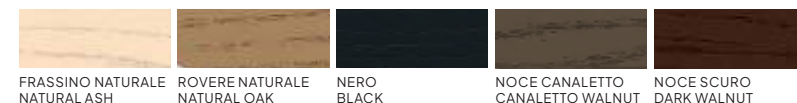

Elementi Elements

KEAHCP75

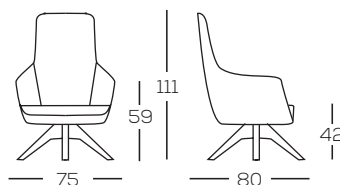

KEAMCP75

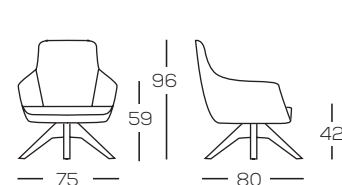

KEABCP75

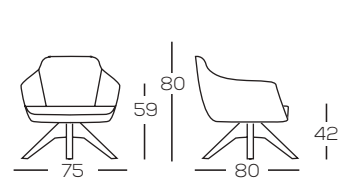

Olympia

Gruppo Fox Design

Caratteristiche Features



- Rivestimenti non sfoderabili.
Non removable covers.
- Struttura della scocca in acciaio, interamente stampata in poliuretano schiumato a freddo.
Steel body structure, entirely molded in cold foamed polyurethane.
- Cuscino sedile stampato in poliuretano schiumato a freddo a doppia densità.
Seat cushion molded in double density cold-foamed polyurethane.
- Basamento girevole in metallo cromato o verniciato nero. Oppure in legno di faggio verniciato nelle finiture frassino naturale, rovere naturale, nero, noce canaletto e noce scuro.
Revolving base in chromed or black painted metal. Or in beech wood painted in natural ash, natural oak, black, canaletto walnut and dark walnut finishes.

Variazioni Variations



R13
BASAMENTO GIREVOLE
IN METALLO
REVOLVING BASE IN METAL



L21
BASAMENTO GIREVOLE
IN LEGNO
REVOLVING BASE IN WOOD

- Basamento girevole (R13) in metallo cromato o verniciato nero.
 - Basamento girevole (L21) in legno di faggio verniciato nelle finiture frassino naturale, rovere naturale, nero, noce canaletto e noce scuro.
- Si prega di specificare le finiture al momento dell'ordine.

- *Revolving base (R13) in chromed or black painted metal.*
 - *Revolving base (L21) in beech wood painted in natural ash, natural oak, black, canaletto walnut and dark walnut finishes.*
- Please specify the finishes when ordering.

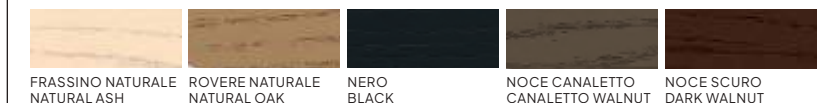

Elementi Elements

OLYCP78

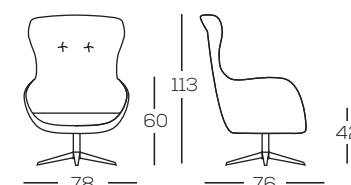

Albertina

GruppoFox Design

Caratteristiche Features



Variazioni Variations



I rivestimenti in pelle sono realizzati con la finitura "taglio a vivo" inclusa nel prezzo.

The leather upholstery is made with the "raw cut" finish included in the price.

Elementi Elements

ALBCP80

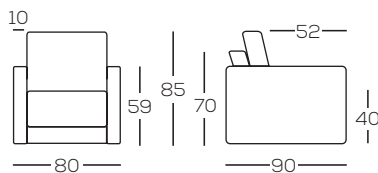

Arrighina

GruppoFox Design

Caratteristiche Features



Variazioni Variations

A richiesta, solo per tessuti e con una maggiorazione del 10%, viene eseguito il bordino in canneté. Si prega di specificare le finiture al momento dell'ordine. Indicare il codice tessuto per riferimento colore. I cuscini sono realizzati in modo da poter essere utilizzati su entrambi i lati (escluso il rivestimento in pelle).

Upon request, only for fabrics and with an increase of 10%, the border in canneté is made. Please specify the finishes when ordering. Indicate the fabric code for color reference. The cushions are made so that they can be used on both sides (excluding the leather cover).

Elementi Elements

ARRCP77

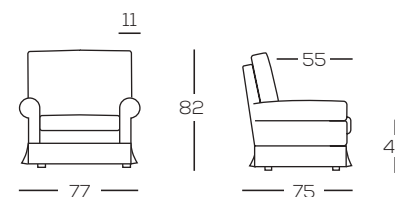

Charlotte

GruppoFox Design

Caratteristiche Features



- Rivestimenti in tessuto completamente sfoderabili.
Fully removable fabric covers.
- Struttura in poliuretano espanso schiumato a freddo sostenuta da una gabbia in tubolare di ferro, il tutto rivestito in vellutino bianco.
Structure in cold foamed polyurethane foam supported by an iron tubular cage, all covered in white velvet.
- Cuscino seduta in poliuretano espanso schiumato a freddo, rivestito in fibre termolegate, ricoperto in tessuto di puro cotone.
Seat cushion in cold-foamed polyurethane foam, covered with heat-bonded fibers, covered in pure cotton fabric.
- Piedi non a vista in legno tinto ciliegio.
Feet not visible in cherry-painted wood.

Elementi Elements

CHACP74

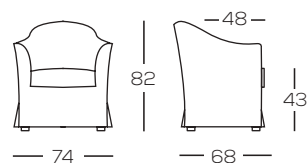

Parigi

GruppoFox Design

Caratteristiche Features



- Rivestimenti in tessuto completamente sfoderabili.
Fully removable fabric covers.
- Struttura in poliuretano espanso schiumato a freddo con inserto in tubolare di ferro, il tutto rivestito in vellutino bianco.
Structure in cold foamed polyurethane with iron tubular insert, all covered in white velvet.
- Gambe a vista in legno, finitura wengé, noce, nero.
Exposed wooden legs in wengé, walnut, black finish.

Variazioni Variations

A richiesta, con un supplemento, è possibile rivestire le gambe in tessuto o pelle.
Si prega di specificare le finiture al momento dell'ordine.

*Upon request, with a price increase, it is possible to cover the legs in fabric or leather.
Please specify the finishes when ordering.*

Elementi Elements

PARCP60

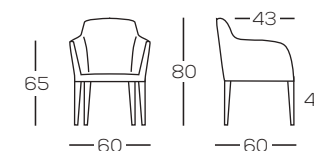

Fanny

GruppoFox Design

Caratteristiche Features



- Rivestimenti in tessuto completamente sfoderabili. La finitura posteriore del rivestimento è con sfondo piega centrale chiuso da un bottone.
Fully removable fabric covers. The rear finish of the upholstery is with a central fold background closed by a button.
- Imbottiture seduta e schienale in poliuretano espanso schiumato a freddo rivestite in vellutino bianco.
Seat and back padding in cold foamed polyurethane covered with white velvet.
- Struttura sedia in profilato di ferro.
Chair structure in iron section.
- Gambe non a vista in legno verniciato wengè.
Non visible legs in wengè painted wood.

Elementi Elements

FANCP45

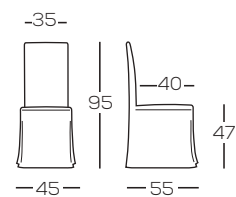

Lapalla

GruppoFox Design

Caratteristiche Features



- Rivestimenti in tessuto completamente sfoderabili.
Fully removable fabric covers.
- Struttura poltrona tubolare di ferro, seduta e schienale con molleggio a cinghie elastiche ed imbottitura in poliuretano espanso schiumato a freddo, il tutto rivestito in vellutino bianco.
Iron tubular armchair structure, seat and backrest with elastic belt springing and padding in cold-foamed polyurethane foam, all covered in white velvet.
- Piedi a vista in acciaio cromato.
Visible feet in chromed steel.
- Struttura pouff in legno e derivati, imbottitura in poliuretano espanso schiumato a freddo, il tutto rivestito in vellutino bianco.
Pouff structure in wood and by-products, padding in cold-foamed polyurethane foam, all covered in white velvet.

Variazioni Variations

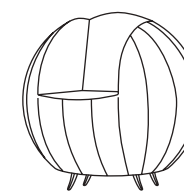

SLICE

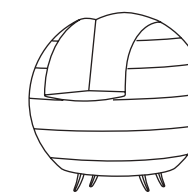

STRIPE

SLICE con cuciture verticali.
STRIPE con cuciture orizzontali.
Si prega di specificare le finiture al momento dell'ordine.

*SLICE with vertical stitching.
STRIPE with horizontal stitching.
Please specify finishings upon order.*

Elementi Elements

LAPCP85

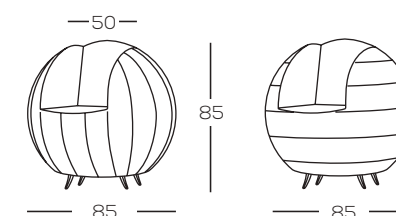

LAPCPF70

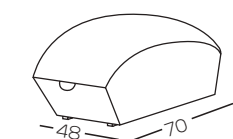

Linda

GruppoFox Design

Caratteristiche Features



- Rivestimenti in tessuto completamente sfoderabili.
Fully removable fabric covers.
- Struttura in poliuretano espanso schiumato a freddo con inserto in tubolare di ferro, il tutto rivestito in vellutino bianco.
Structure in cold foamed polyurethane with iron tubular insert, all covered in white velvet.
- Gambe a vista in metallo cromato.
Exposed legs in chromed metal.

Elementi Elements

LINCP60

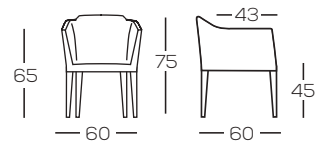

Margot

GruppoFox Design

Caratteristiche Features



- Rivestimenti in tessuto completamente sfoderabili.
Fully removable fabric covers.
- Struttura in poliuretano espanso schiumato a freddo sostenuta da una gabbia in tubolare di ferro, il tutto rivestito in vellutino bianco.
Structure in cold foamed polyurethane foam supported by an iron tubular cage, all covered in white velvet.
- Cuscino seduta in vera piuma, ricoperto in tessuto di puro cotone a tenuta di piuma.
Seat cushion in real feather, covered in feather-tight pure cotton fabric.
- Piedi a vista in legno tinto ciliegio.
Exposed feet in cherry stained wood.

Elementi Elements

MARCP65

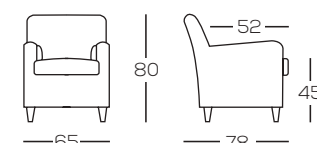

Milady

GruppoFox Design

Caratteristiche Features



- Rivestimenti in tessuto completamente sfoderabili.
Fully removable fabric covers.
- Struttura in poliuretano espanso schiumato a freddo sostenuta da una gabbia in tubolare di ferro, il tutto rivestito in vellutino bianco.
Structure in cold foamed polyurethane foam supported by an iron tubular cage, all covered in white velvet.
- Cuscino seduta in poliuretano espanso schiumato a freddo, rivestito in fibre termolegate, ricoperto in tessuto di puro cotone.
Seat cushion in cold-foamed polyurethane foam, covered with heat-bonded fibers, covered in pure cotton fabric.
- Piedi a vista in legno tinto ciliegio, quelli anteriori dispongono di ruote in metallo.
Exposed feet in cherry stained wood, the front ones have metal wheels.

Variazioni Variations



A richiesta i piedi anteriori sono disponibili senza ruotine.
A richiesta, solo per tessuti e con una maggiorazione, viene eseguito il bordino in contrasto in canneté. Si prega di indicare il codice del tessuto per riferimento colore.
Si prega di specificare le finiture al momento dell'ordine.

*Upon request the front feet are available without wheels.
Upon request, only for fabrics and with a price increase, the border in canneté is made. Please indicate the fabric code for color reference.
Please specify the finishes when ordering.*

Elementi Elements

MILCP75

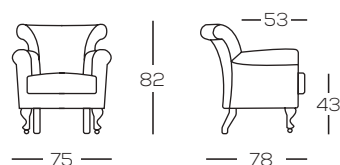

Susanna

GruppoFox Design

Caratteristiche Features



- Rivestimenti in tessuto completamente sfoderabili.
Fully removable fabric covers.
- Struttura poltrona in poliuretano espanso schiumato a freddo sostenuta da una gabbia in tubolare di ferro, il tutto rivestito in vellutino bianco.
Armchair structure in cold-foamed polyurethane foam supported by an iron tubular cage, all covered in white velvet.
- Cuscino seduta in vera piuma, ricoperto in tessuto di puro cotone a tenuta di piuma.
Seat cushion in real feather, covered in feather-tight pure cotton fabric.
- Piedi non a vista in legno tinto ciliegio.
Feet not visible in cherry-painted wood.
- Struttura pouff in legno e derivati con imbottitura in poliuretano espanso, il tutto rivestito in vellutino bianco.
Wooden pouff structure and derivatives with polyurethane foam padding, all covered in white velvet.

Variazioni Variations

A richiesta, solo per tessuti e con una maggiorazione del 10%, viene eseguito il bordino in contrasto in canneté. Si prega di indicare il codice in tessuto per riferimento colore.
Si prega di specificare le finiture al momento dell'ordine.

*Upon request, only for fabrics and with an increase of 10%, the border in canneté is made.
Please indicate the fabric code for color reference.
Please specify the finishes when ordering.*

Elementi Elements

SUSCP84

SUSCPF50

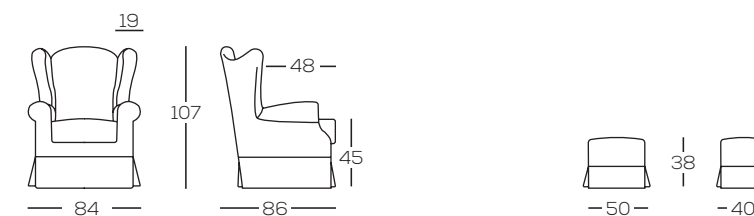

Pouff

GruppoFox Design

Caratteristiche Features



- Rivestimenti in tessuto completamente sfoderabili.
Fully removable fabric covers.
- Struttura in legno e derivati con imbottitura in poliuretano espanso, il tutto rivestito in vellutino bianco.
Structure in wood and derivatives with springing with elastic belts and padding in polyurethane foam, all covered in velvet.
- Piedi a vista semisferici in acciaio lucidato.
Visible hemispherical feet in polished steel.

Variazioni Variations

A richiesta, solo per tessuti e con una maggiorazione, viene eseguito il bordino in contrasto in canneté.
Si prega di indicare il codice in tessuto per referenza colore.
Si prega di specificare le finiture al momento dell'ordine.

*Upon request, only for fabrics and with a price increase, the border in canneté is made.
Please indicate the fabric code for color reference.
Please specify the finishes when ordering.*

Elementi Elements

PFC40

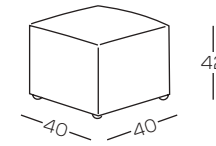

PFC50

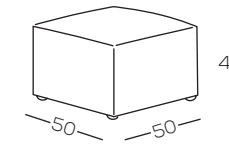

PFC60

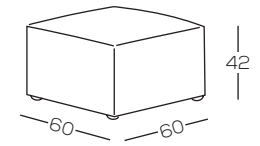

PFC70

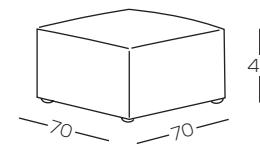

PFC80

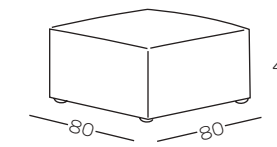

PFC100

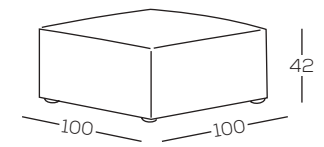

PFCR40

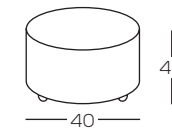

PFCR70

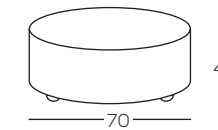

PFCR100

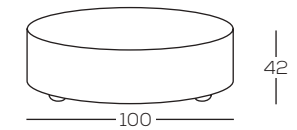

Ambrogio

GruppoFox Design

Caratteristiche
Features



- Server. Ideale per modelli: Boss, Levante, Levante Air, Asso.
Server. Works best with models: Boss, Levante, Levante Air, Asso.

Variazioni
Variations

AMB 55V	Struttura in metallo bronzato, top in vetro retroverniciato nero opaco <i>Bronzed metal structure, top in back painted matte black glass</i>
AMB 55R	Struttura in metallo bronzato, top in rovere <i>Bronzed metal structure, top in durmast</i>
AMB 55NC	Struttura in metallo bronzato, top in noce canaletto <i>Bronzed metal structure, top in canaletto walnut</i>

Si prega di specificare le finiture al momento dell'ordine.
Please specify the finishes when ordering.

Elementi
Elements

AMB 55V - AMB 55R - AMB 55NC

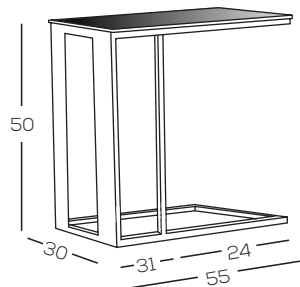

Cassandra

GruppoFox Design

Caratteristiche
Features



- Consolle. Ideale per modelli: Amalfi.
Consolle. Works best with models: Amalfi.

Variazioni
Variations

CAS 140	Struttura in metallo bronzato, piano in noce canaletto <i>Bronzed metal structure, top in canaletto walnut</i>
	Struttura in metallo bronzato, piano in vetro retroverniciato grigio <i>Bronzed metal structure, top in back-lacquered grey glass</i>
	Struttura in metallo bronzato, piano in vetro retroverniciato cipria <i>Bronzed metal structure, top in back-lacquered powder glass</i>

Si prega di specificare le finiture al momento dell'ordine.
Please specify the finishes when ordering.

Elementi
Elements

CAS 140

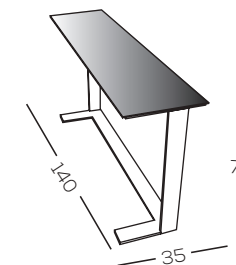

Medusa

GruppoFox Design

Caratteristiche
Features



• Tavolini
Coffee tables

Variazioni
Variations

Si prega di specificare le finiture al momento dell'ordine.
Please specify the finishes when ordering.

FINITURE TOP
TOP FINISHES



VETRO TEMPERATO AZZURRO
BLUE TEMPERED GLASS



VETRO TEMPERATO VERDE
GREEN TEMPERED GLASS

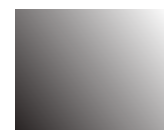

VETRO TEMPERATO NERO
BLACK TEMPERED GLASS



VETRO TEMPERATO BIANCO
WHITE TEMPERED GLASS

FINITURE STRUTTURA
STRUCTURE FINISHES



SABBIA
SAND



BRONZO
BRONZE



MASTICE
MASTIC



ANTRACITE
ANTHRACITE

Vernici resistenti alla nebbia salina / Saline fog resistant varnishes

Elementi
Elements

MEDS43

MEDM55

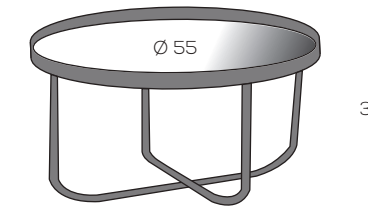
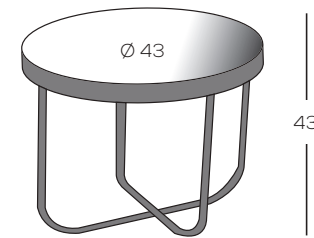

Note
Notes



La base decentrata permette al tavolino Medusa S di adattarsi perfettamente agli angoli delle sedute Levante.
La stessa caratteristica permette ai tavolini Medusa S e M di unirsi tra loro, per creare una unica composizione.

The decentralized base allows the Medusa coffee table to adapt perfectly to the corners of the Levante seats.
The same feature allows the Medusa S and M coffee tables to join together to create a single composition.

Perseo

GruppoFox Design

Caratteristiche
Features



• Trittico di tavolini componibili
Modular coffee tables tryptych

Variazioni
Variations

Si prega di specificare le finiture al momento dell'ordine.
Please specify the finishes when ordering.

FINITURE STRUTTURA
STRUCTURE FINISHES



SABBIA
SAND



BRONZO
BRONZE



MASTICE
MASTIC



ANTRACITE
ANTHRACITE

Vernici resistenti alla nebbia salina / *Saline fog resistant varnishes*

Elementi
Elements

PERS65

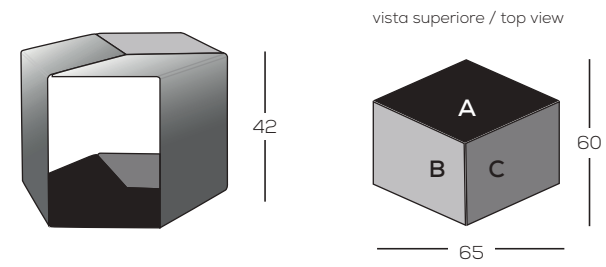

PERSEO è un trittico di tavolini componibili.
Gli elementi componibili Perseo (A, B e C) hanno misure diverse tra loro per facilitare la composizione del trittico.

*PERSEO is a tryptych of modular coffee tables.
The modular elements Perseo (A, B and C) have different sizes to facilitate the composition of the tryptych.*

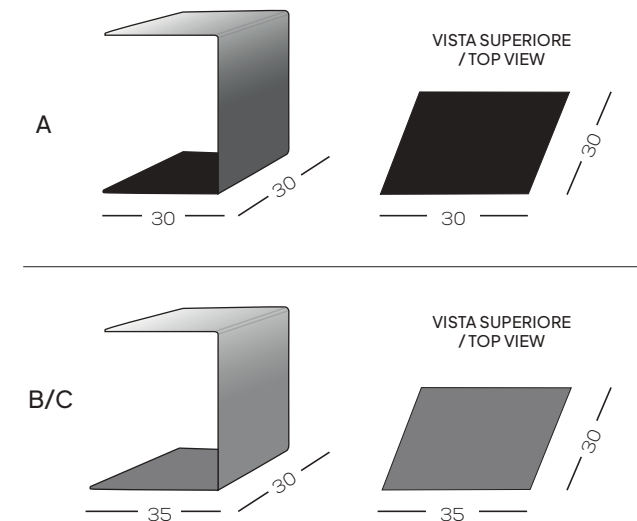

Note
Notes



Un solo elemento Perseo è utilizzabile anche singolarmente come server per le sedute della collezione divani Gruppo Fox.

A single Perseo element can also be used individually, as a server for the seats of the Gruppo Fox sofa collection.



GRUPPO**FOX**

GRUPPO FOX s.r.l. - Via Degli Artigiani, 9
20853 Biassono (MB) Italy
Tel. +39 039.2495865
www.gruppofox.it - info@gruppofox.it

PHOTOGRAPHY:
Mauro Casagrande - Studio Eleven

LAYOUT AND PRINT:
Modulgrafica Forlivese SPA
Italy 2024

© GRUPPO FOX
tutti i diritti riservati

Nella stampa su carta la tonalità dei colori dei vari materiali
non può essere riprodotta fedelmente.
Pertanto la resa deve considerarsi indicativa e non potrà
costituire motivo di contestazione del prodotto.

*When printed on paper the hues and colors of the various
materials cannot be faithfully reproduced.
Therefore the output must be considered indicative and
cannot constitute a reason for contesting the product.*



GRUPPOFOX